

# Operating Manual

C / C-UL (E7)

CO<sub>2</sub> Incubator

with FPI-sensor system and RD4controller

Model	Model version	Art. No.
C 170	C170-230V	9040-0163, 9140-0163
C 170-UL	C170UL-120V	9040-0164, 9140-0164

## **BINDER GmbH**

- ▶ Address: Post office box 102, 78502 Tuttlingen, Germany ▶ Phone: +49 7462 2005 0
- ▶ Fax: +49 7462 2005 100 ▶ Internet: <http://www.binder-world.com>
- ▶ E-mail: [info@binder-world.com](mailto:info@binder-world.com) ▶ Service Hotline: +49 7462 2005 555
- ▶ Service Fax: +49 7462 2005 93 555 ▶ Service E-Mail: [service@binder-world.com](mailto:service@binder-world.com)
- ▶ Service Hotline USA: +1 866 885 9794 or +1 631 224 4340 x3
- ▶ Service Hotline Asia Pacific: +852 390 705 04 or +852 390 705 03
- ▶ Service Hotline Russia and CIS: +7 495 988 15 16

## Contents

<b>1. SAFETY</b>	<b>6</b>
1.1 Legal considerations	6
1.2 Structure of the safety instructions	6
1.2.1 Signal word panel	6
1.2.2 Safety alert symbol	7
1.2.3 Pictograms	7
1.2.4 Word message panel structure	8
1.3 Localization / position of safety labels at the chamber	8
1.4 Type plate	9
1.5 General safety instructions on installing and operating the chamber	10
1.6 Precautions when working with CO <sub>2</sub> gas	12
1.7 Precautions when handling gas cylinders	12
1.8 Intended use	13
1.9 Operating instructions	14
1.10 Measures to prevent accidents	14
<b>2. CHAMBER DESCRIPTION</b>	<b>15</b>
2.1 Chamber overview	16
2.2 Inner chamber	17
2.3 Connection panel on the rear of the chamber	18
2.4 Chamber doors	19
2.5 Instrument panel	19
<b>3. COMPLETENESS OF DELIVERY, TRANSPORTATION, STORAGE, AND INSTALLATION</b>	<b>20</b>
3.1 Unpacking, and checking equipment and completeness of delivery	20
3.2 Guidelines for safe lifting and transportation	21
3.3 Storage	21
3.4 Location of installation and ambient conditions	21
<b>4. INSTALLATION AND CONNECTIONS</b>	<b>24</b>
4.1 Shelf holder and shelves	24
4.2 CO <sub>2</sub> sensor	25
4.2.1 Connecting the CO <sub>2</sub> sensor	25
4.2.2 General notes	25
4.3 Water pan	26
4.4 Gas connection	27
4.4.1 Connecting the CO <sub>2</sub> gas cylinder	28
4.4.2 Connecting the gas hose to the chamber rear	29
4.4.3 Gas cylinder connection kit (option)	30
4.5 Electrical connection	31
<b>5. FUNCTIONAL OVERVIEW OF THE RD4 CHAMBER CONTROLLER</b>	<b>32</b>
5.1 Menu structure of the controller and access levels	33
5.2 Performance during and after power failures and shut down	34
<b>6. START UP</b>	<b>34</b>
6.1 Turning on the chamber	34
6.2 Preset factory parameters	35
6.3 Performance after turning on the chamber	35
6.4 Altitude of the installation site above sea level	36
<b>7. TEMPERATURE AND CO<sub>2</sub> SET-POINT ENTRY</b>	<b>37</b>
7.1 Temperature set-point entry	37
7.2 CO <sub>2</sub> set-point entry	37

<b>8.</b>	<b>PLACING SAMPLES IN THE INCUBATOR .....</b>	<b>38</b>
<b>9.</b>	<b>SETTING SPECIAL CONTROLLER FUNCTIONS .....</b>	<b>39</b>
9.1	Idle mode.....	39
9.2	Deactivated CO <sub>2</sub> control.....	40
<b>10.</b>	<b>PASSWORD.....</b>	<b>40</b>
10.1	Password request .....	40
10.2	Assign and modify a password .....	41
10.2.1	Assign and modify the User password .....	41
10.2.2	Assign and modify the Admin password.....	41
<b>11.</b>	<b>TEMPERATURE SAFETY DEVICES.....</b>	<b>42</b>
11.1	Over temperature protective device (class 1) .....	42
11.2	Overtemperature safety controller class 3.1 .....	42
11.2.1	Setting the safety controller mode .....	43
11.2.2	Setting the safety controller value.....	43
11.2.3	Message and measures in the state of alarm.....	44
11.2.4	Function check.....	44
<b>12.</b>	<b>GENERAL CONTROLLER SETTINGS.....</b>	<b>45</b>
12.1	Selecting the controller's menu language .....	45
12.2	Selecting the temperature unit .....	45
12.3	Setting the current date.....	46
12.4	Setting the current time .....	47
12.5	Function "Language selection at restart" .....	47
12.6	Setting the chamber address .....	48
12.7	Display brightness.....	48
<b>13.</b>	<b>TOLERANCE RANGE SETTINGS.....</b>	<b>49</b>
13.1	Setting the delay time for tolerance range alarm .....	49
13.2	Setting the temperature tolerance range .....	49
13.3	Setting the CO <sub>2</sub> tolerance range .....	50
13.4	Setting the delay time for door open alarm .....	50
<b>14.</b>	<b>CHAMBER SETTINGS (FOR EXPERIENCED USERS ONLY).....</b>	<b>51</b>
14.1	Setting the humidity control.....	51
14.2	Setting the door heating offset.....	51
14.3	Adjusting the heating power – for BINDER Service only .....	52
<b>15.</b>	<b>NOTIFICATION AND ALARM FUNCTIONS.....</b>	<b>53</b>
15.1	Alarm messages .....	53
15.2	Information messages.....	55
15.3	Activating / deactivating the audible alarm (alarm buzzer) .....	55
15.4	Measures in case of alarm .....	56
15.4.1	Door open alarm .....	56
15.4.2	Safety controller temperature alarm .....	56
15.4.3	Temperature tolerance range alarm (overtemperature / too low temperature) .....	57
15.4.4	CO <sub>2</sub> tolerance range alarm (CO <sub>2</sub> over/under concentration) .....	58
15.4.5	CO <sub>2</sub> pressure alarm .....	59
15.4.6	Power failure alarm.....	59
15.4.7	Alarms referring to temperature sensor failures .....	60
15.4.8	Alarms referring to CO <sub>2</sub> sensor failure .....	61
15.4.9	Alarm on ineffective sterilization .....	61
15.5	Zero-voltage relay alarm output.....	62
<b>16.</b>	<b>ETHERNET NETWORK SETTINGS.....</b>	<b>63</b>
16.1	Showing the network settings .....	63
16.1.1	Showing the chamber's MAC address.....	63

16.1.2	Showing the IP address.....	63
16.1.3	Showing the subnet mask.....	64
16.1.4	Showing the standard gateway.....	64
16.1.5	Showing the DNS server address.....	64
16.1.6	Showing the DNS chamber name .....	65
16.2	Changing the configuration of the network settings.....	65
16.2.1	Selecting the type of IP address assignment (automatic / manual) .....	65
16.2.2	Selecting the type of assignment of the DNS server address (automatic / manual) .....	66
16.2.3	Assigning the IP address .....	66
16.2.4	Setting the subnet mask .....	67
16.2.5	Setting the standard gateway .....	67
16.2.6	Assigning the DNS server address.....	68
<b>17.</b>	<b>DATA RECORDER .....</b>	<b>69</b>
17.1	Recorded data.....	69
17.2	Storage capacity .....	69
17.3	Setting the storage rate for the “DL1” recorder data .....	70
17.4	Deleting the data recorder.....	70
<b>18.</b>	<b>USB MENU: DATA TRANSFER VIA USB INTERFACE .....</b>	<b>71</b>
18.1	Connecting the USB stick .....	71
18.2	Import function .....	71
18.3	Export functions .....	72
18.4	Ongoing data transfer .....	72
18.5	Error during data transmission.....	73
18.6	Removing the USB stick .....	73
<b>19.</b>	<b>REFERENCE MEASUREMENTS .....</b>	<b>74</b>
19.1	CO <sub>2</sub> reference measuring .....	74
19.1.1	Measuring the CO <sub>2</sub> concentration indirectly via the pH of the cell medium.....	74
19.1.2	Measuring CO <sub>2</sub> directly via chemical indicator tubes.....	75
19.1.3	Measuring CO <sub>2</sub> directly with an electronic infrared measuring device .....	76
19.2	Temperature reference measurement .....	76
<b>20.</b>	<b>OPTIONS.....</b>	<b>76</b>
20.1	Silicone access ports 30 mm / 1.18 in, closable with 2 silicone plugs (8012-0558 rear, 8012-0559 left, 8012-0560 right) (option).....	76
20.2	Base on castors (option) .....	77
20.3	Stacking adapter for direct thermal decoupled stacking (option).....	77
20.4	APT-COM™ 4 Multi Management Software (option).....	77
20.5	Data logger kit (option).....	77
20.6	Analog outputs for temperature and CO <sub>2</sub> (option) .....	78
<b>21.</b>	<b>AVOIDING MICROBIAL CONTAMINATION.....</b>	<b>79</b>
21.1	Cells and media .....	79
21.2	Laboratory conditions / equipment around the CO <sub>2</sub> incubator .....	79
21.3	Working and behavior in the lab .....	79
21.4	Chamber design and equipment.....	80
21.5	Handling the CO <sub>2</sub> incubator .....	81
<b>22.</b>	<b>CLEANING, DECONTAMINATION / DISINFECTION, AND STERILIZATION ....</b>	<b>82</b>
22.1	Cleaning .....	82
22.2	Decontamination / chemical disinfection of the chamber.....	83
22.3	Disinfection of the CO <sub>2</sub> sensor .....	85
<b>23.</b>	<b>HOT-AIR STERILIZATION AT 180 °C / 356 °F.....</b>	<b>86</b>
23.1	Overview .....	86
23.2	Performing a hot-air sterilization .....	87
23.2.1	Preparations for hot-air sterilization .....	87



23.3	Starting and running the hot-air sterilization cycle .....	88
23.3.1	Starting sterilization.....	88
23.3.2	Performance during sterilization .....	88
23.3.3	Completing the entire sterilization cycle .....	89
23.4	Prematurely terminating the sterilization cycle – effects.....	90
23.4.1	Premature termination after less than 6 hours: Ineffective sterilization.....	90
23.4.2	Premature termination after more than 6 hours, i.e., during the cooling-down phase: successful sterilization .....	90
23.5	Prematurely terminating the sterilization cycle – procedure .....	91
23.5.1	Cancelling sterilization via the controller menu .....	91
23.5.2	Opening the outer door .....	92
23.5.3	Turning off the chamber.....	92
<b>24.</b>	<b>MAINTENANCE, AND SERVICE.....</b>	<b>93</b>
24.1	Maintenance intervals, service.....	93
24.2	Service Reminder.....	93
24.3	Gas inlet fine filter .....	94
24.4	Sending the chamber back to BINDER GmbH .....	94
<b>25.</b>	<b>DISPOSAL.....</b>	<b>95</b>
25.1	Disposal of the transport packing.....	95
25.1.1	Outer chamber packing.....	95
25.1.2	Packing inside the chamber, equipment.....	95
25.2	Decommissioning.....	96
25.3	Disposal of the chamber in the Federal Republic of Germany .....	96
25.4	Disposal of the chamber in the member states of the EU except for the Federal Republic of Germany.....	97
25.5	Disposal of the chamber in non-member states of the EU .....	98
<b>26.</b>	<b>TROUBLESHOOTING .....</b>	<b>99</b>
26.1	General.....	99
26.2	Temperature.....	99
26.3	CO <sub>2</sub> .....	100
26.4	Humidity .....	101
26.5	Controller.....	102
26.6	Sterilization.....	102
<b>27.</b>	<b>TECHNICAL DESCRIPTION.....</b>	<b>103</b>
27.1	Factory calibration and adjustment .....	103
27.2	Over current protection .....	103
27.3	Definition of usable volume .....	103
27.4	C / C-UL technical data .....	104
27.5	Important conversion data for non-SI units .....	105
27.6	Conversion table for gas inlet pressures, bar – psi.....	106
27.7	Equipment and options (extract) .....	106
27.8	Options, accessories, and spare parts (extract) .....	107
27.9	Dimensions C 170.....	108
<b>28.</b>	<b>CERTIFICATES AND DECLARATIONS OF CONFORMITY.....</b>	<b>109</b>
28.1	EU Declaration of Conformity.....	109
<b>29.</b>	<b>PRODUCT REGISTRATION .....</b>	<b>111</b>
<b>30.</b>	<b>CONTAMINATION CLEARANCE CERTIFICATE .....</b>	<b>112</b>
30.1	For chambers located outside the USA and Canada .....	112
30.2	For chambers in the USA and Canada .....	115

Dear Customer,

For the correct operation of the CO<sub>2</sub> incubator C / C-UL, it is important that you read this operating manual completely and carefully and observe all instructions as indicated. Failure to read, understand and follow the instructions may result in personal injury. It can also lead to damage to the chamber and/or poor equipment performance.

## 1. Safety

This operating manual is part of the components of delivery. Always keep it handy for reference. The device should only be operated by laboratory personnel especially trained for this purpose and familiar with all precautionary measures required for working in a laboratory. Observe the national regulations on minimum age of laboratory personnel. To avoid injury and damage observe the safety instructions in the operating manual.

	 <b>WARNING</b>
<p><b>Failure to observe the safety instructions.</b> <b>Serious injuries and chamber damage.</b></p> <ul style="list-style-type: none"><li>➤ Observe the safety instructions in this operating manual</li><li>➤ Carefully read the complete operating instructions for the chamber.</li></ul>	

### 1.1 Legal considerations

This operating manual is for informational purposes only. It contains information for installing, start-up, operation and maintenance of the product. Note: the contents and the product described are subject to change without notice.

Understanding and observing the instructions in this operating manual are prerequisites for hazard-free use and safety during operation and maintenance. In no event shall BINDER be held liable for any damages, direct or incidental arising out of or related to the use of this manual.

This operating manual cannot cover all conceivable applications. If you would like additional information, or if special problems arise that are not sufficiently addressed in this manual, please ask your dealer or contact us directly by phone at the number located on page one of this manual

Furthermore, we emphasize that the contents of this operating manual are not part of an earlier or existing agreement, description, or legal relationship, nor do they modify such a relationship. All obligations on the part of BINDER derive from the respective purchase contract, which also contains the entire and exclusively valid statement of warranty administration. The statements in this manual neither augment nor restrict the contractual warranty provisions.

### 1.2 Structure of the safety instructions

In this operating manual, the following safety definitions and symbols indicate dangerous situations in accordance with the standards ISO 3864-2 and ANSI Z535.6.

#### 1.2.1 Signal word panel

Depending on the seriousness and probability of serious consequences, potential dangers are identified with a signal word, the corresponding safety color, and if appropriate, the safety alert symbol.

 <b>DANGER</b>
Indicates an imminently hazardous situation that, if not avoided, will result in death or serious (irreversible) injury.

**WARNING**

Indicates a potentially hazardous situation which, if not avoided, could result in death or serious (irreversible) injury

**CAUTION**

Indicates a potentially hazardous situation which, if not avoided, may result in moderate or minor (reversible) injury

**CAUTION**

Indicates a potentially hazardous situation, which, if not avoided, may result in damage to the product and/or its functions or to property in its proximity.

### 1.2.2 Safety alert symbol



Use of the safety alert symbol indicates a **risk of injury**.

Observe all measures that are marked with the safety alert symbol in order to avoid death or injury.

### 1.2.3 Pictograms

Warning signs			
Electrical hazard	Hot surface	Explosive Atmosphere	Stability hazard
Lifting hazard	Gas cylinders	CO <sub>2</sub> suffocation and poisoning hazard	Pollution Hazard
Harmful substances	Biohazard	Risk of corrosion and / or chemical burns	
Mandatory action signs			
Mandatory regulation	Read operating instructions	Disconnect the power plug	Lift with several persons
Environment protection	Wear protective gloves	Wear safety goggles	

Prohibition signs			
Do NOT touch	Do NOT spray with water	Do NOT climb	
	Information to be observed in order to ensure optimum function of the product.		

### 1.2.4 Word message panel structure

<p><b>Type / cause of hazard.</b></p> <p><b>Possible consequences.</b></p> <ul style="list-style-type: none"> <li>∅ Instruction on how to avoid the hazard: prohibition</li> <li>➤ Instruction on how to avoid the hazard: mandatory action</li> </ul>
--

Observe all other notes and information not necessarily emphasized in the same way, in order to avoid disruptions that could result in direct or indirect injury or property damage.

### 1.3 Localization / position of safety labels at the chamber

The following labels are located on the chamber:

Pictograms (Warning signs)	Service label
<p>Hot surface</p>	
<p>Risk of injury (UL chambers only). Observe the safety instructions in the operating manual.</p>	

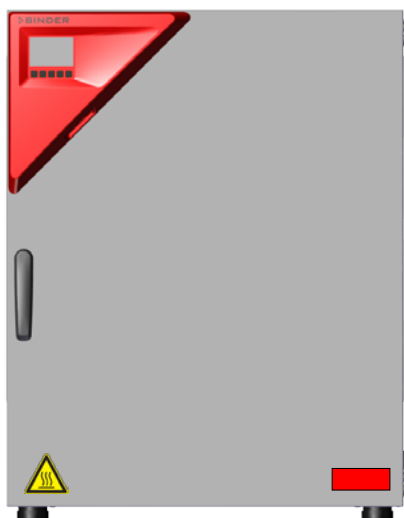

Figure 1: Position of labels on the CO<sub>2</sub> incubator C

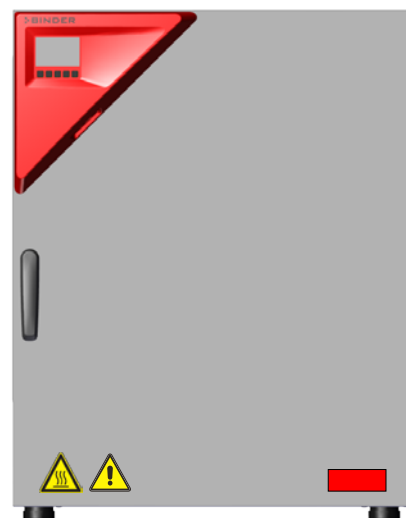

Figure 2: Position of labels on the CO<sub>2</sub> incubator C-UL





Keep safety labels complete and legible.

Replace safety labels that are no longer legible. Contact BINDER Service for these replacements.

## 1.4 Type plate

Position of type plate: left chamber side (seen from front), at the bottom in the middle.

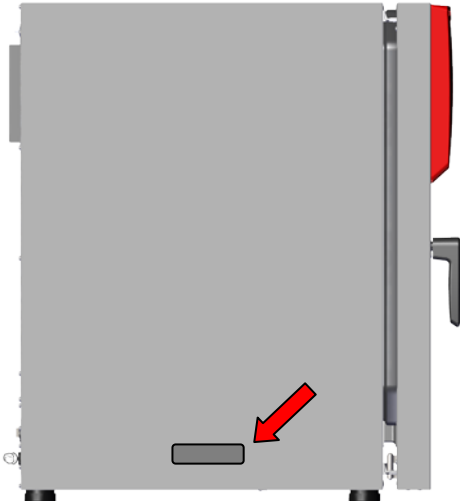

Figure 3: Position of type plate

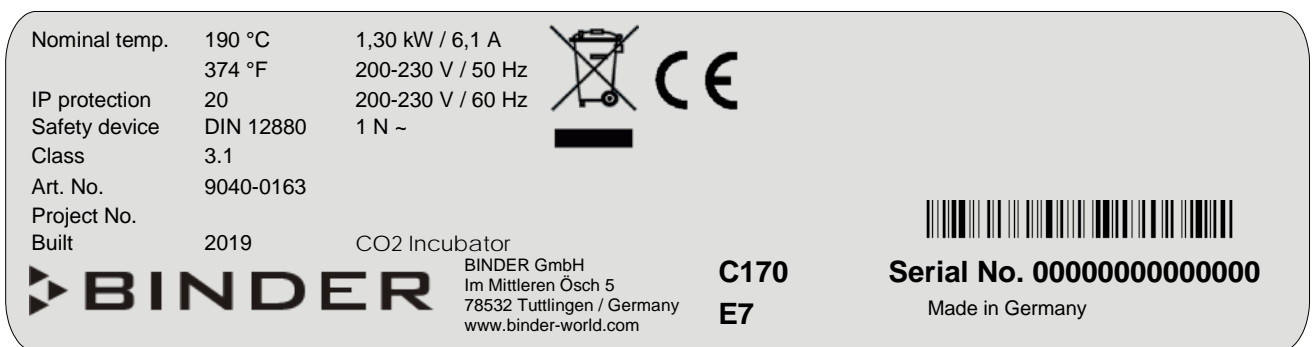



Figure 4: Type plate (example C 170 standard chamber, door hinged right)

Indications of the type plate (example)		Information
BINDER		Manufacturer: BINDER GmbH
C 170		Model designation
CO2 Incubator		Device name: CO <sub>2</sub> Incubator
Serial No.	000000000000	Serial No. of the chamber
Built	2019	Year of construction
Nominal temperature	190 °C 374 °F	Nominal temperature
IP protection	20	Type of IP protection acc. to standard EN 60529
Temp. safety device	DIN 12880	Temperature safety device acc. to standard DIN 12880:2007
Class	3.1	Class of temperature safety device
Art. No.	9040-0163	Art. No. of the chamber
Project No.	---	Optional: Special application acc. to project no.

Indications of the type plate (example)	Information
1,30 kW	Nominal power
6,1 A	Nominal current
200-230 V / 50 Hz	Nominal voltage range +/- 10% at the indicated power frequency
200-230 V / 60 Hz	
1 N ~	Current type

Symbol on the type plate	Information
	CE conformity marking
	Electrical and electronic equipment manufactured / placed on the market in the EU after 13 August 2005 and to be disposed of in a separate collection according to Directive 2012/19/EU on waste electrical and electronic equipment (WEEE).

## 1.5 General safety instructions on installing and operating the chamber



With regard to operating the chamber and to the installation location, please observe the DGUV guidelines 213-850 on safe working in laboratories, issued by the employers' liability insurance association (for Germany).

BINDER GmbH is only responsible for the safety features of the chamber provided skilled electricians or qualified personnel authorized by BINDER perform all maintenance and repair, and if components relating to chamber safety are replaced in the event of failure with original spare parts.



To operate the chamber, use only original BINDER accessories or accessories from third-party suppliers authorized by BINDER. The user is responsible for any risk caused by using unauthorized accessories.

<b>CAUTION</b>	
	<p><b>Danger of overheating.</b> <b>Damage to the chamber.</b></p> <ul style="list-style-type: none"> <li>⊘ Do NOT install the chamber in unventilated recesses.</li> <li>➤ Ensure sufficient ventilation for dispersal of the heat.</li> </ul>

Do not operate the chamber in hazardous locations.



 <b>DANGER</b>	
	<p><b>Explosion hazard.</b> <b>Danger of death.</b></p> <ul style="list-style-type: none"> <li>⊘ Do NOT operate the chamber in potentially explosive areas.</li> <li>⊘ KEEP explosive dust or air-solvent mixtures AWAY from the chamber.</li> </ul>

The chamber does not dispose of any measures of explosion protection.

	 <b>DANGER</b>
	<p><b>Explosion hazard.</b> <b>Danger of death.</b></p> <ul style="list-style-type: none"> <li>∅ Do NOT introduce any substance into the CO<sub>2</sub> incubator which is combustible or explosive at working temperature.</li> <li>∅ NO explosive dust or air-solvent mixture in the inner chamber.</li> </ul>



Any solvent contained in the charging material must not be explosive or inflammable. I.e., irrespective of the solvent concentration in the steam room, NO explosive mixture with air must form. The temperature inside the chamber must lie below the flash point or below the sublimation point of the charging material. Familiarize yourself with the physical and chemical properties of the charging material, as well as the contained moisture constituent and its behavior with the addition of heat energy and humidity.



Familiarize yourself with any potential health risks caused by the charging material, the contained moisture constituent or by reaction products that may arise during the temperature process. Take adequate measures to exclude such risks prior to putting the CO<sub>2</sub> incubator into operation.

	 <b>DANGER</b>
	<p><b>Electrical hazard.</b> <b>Danger of death.</b></p> <ul style="list-style-type: none"> <li>∅ The chamber must NOT become wet during operation or maintenance.</li> </ul>

The chambers were produced in accordance with VDE regulations and were routinely tested in accordance to VDE 0411-1 (IEC 61010-1).



During and shortly after operation, the temperature of the inner surfaces almost equals the set-point.

	 <b>CAUTION</b>
	<p><b>The glass door, the glass door handle and the inner chamber will become hot during operation.</b> <b>Danger of burning.</b></p> <ul style="list-style-type: none"> <li>∅ Do NOT touch the glass door, the glass door handle, the inner surfaces or the charging material during operation.</li> </ul>

 	 <b>WARNING</b>
	<p><b>Stability hazard.</b> <b>Danger of injury.</b> <b>Damage to the chamber and the charging material.</b> <b>Housing cover breakaway.</b></p> <ul style="list-style-type: none"> <li>∅ Do NOT climb on the lower housing cover.</li> <li>∅ Do NOT load the lower housing cover with heavy objects while the chamber door is open.</li> </ul>

## 1.6 Precautions when working with CO<sub>2</sub> gas



Carbon dioxide (CO<sub>2</sub>) in high concentrations is hazardous to health. It is colorless and almost odorless and therefore practically imperceptible. Vent out any CO<sub>2</sub> gas that may escape via good room ventilation or a suitable connection to an exhaust system. We recommend installing a CO<sub>2</sub> warning system.

	 <b>WARNING</b>
	<p><b>High concentration of CO<sub>2</sub> (&gt; 4 Vol.-%).</b>  <b>Risk of death by suffocation.</b>  <b>Danger of poisoning.</b></p> <ul style="list-style-type: none"> <li>∅ Do NOT set up chambers in non-ventilated recesses</li> <li>➤ Ensure technical ventilation measures</li> <li>➤ Observe the relevant regulations for handling CO<sub>2</sub>.</li> </ul>



## 1.7 Precautions when handling gas cylinders

	<p>General information for safe handling of gas cylinders:</p> <ul style="list-style-type: none"> <li>• Store and use gas cylinders only in well-ventilated locations.</li> <li>• Open the gas cylinder valve slowly to avoid pressure surges</li> <li>• Secure gas cylinders during storage and use against falling (chaining).</li> <li>• Transport gas cylinders with a cylinder cart, do not carry, roll, or throw them.</li> <li>• Always close the valve even with apparently empty cylinders; screw on the cap when not in use. Return gas cylinders with the valve closed.</li> <li>• Do not open gas cylinders by force. Mark them when damaged</li> <li>• Protect gas cylinders against fire, e.g. do not store together with flammable liquids</li> <li>• Observe relevant regulations for dealing with gas cylinders.</li> </ul>
---	--

Secure the gas cylinders against falling and other mechanical damage.

	 <b>WARNING</b>
	<p><b>Safety valve tearing off.</b>  <b>Sudden release of the stored pressure energy.</b>  <b>Risk of injury.</b></p> <ul style="list-style-type: none"> <li>➤ Secure gas cylinders against falling (chaining).</li> <li>➤ Transport gas cylinders with a cylinder cart.</li> </ul>

The valve of the gas cylinder **always** must be closed before screwing on or unscrewing the gas hose.



	 <b>WARNING</b>
	<p><b>Opening the cylinder valve when the cylinder is not connected.</b>  <b>Sudden release of the stored pressure energy.</b>  <b>Risk of injury.</b></p> <ul style="list-style-type: none"> <li>➤ Close the gas cylinder valve before connecting or removing the gas hose.</li> </ul>

	<p>After connecting the gas cylinder, check all gas connections for leaks (e.g. with leak spray or diluted soap solution).</p>
---	--

## 1.8 Intended use

CO<sub>2</sub> incubators C / C-UL are suitable for the cultivation of mammal cells under typical conditions of approx. 37 °C / 98.6 °F. The chambers permit setting defined pH conditions by common NaHCO<sub>3</sub> buffer systems of commercial cell media by keeping an exact CO<sub>2</sub> atmosphere inside. The chambers guarantee high humidity inside to avoid osmolarity increasing caused by the evaporation of the cell media.

The chambers are suitable for exact conditioning of harmless materials. Any possible solvent any solvent must not be explosive and flammable. Components of the charging material must NOT form an explosive mixture with air. The operating temperature must lie below the flash point or below the sublimation point of the charging material. Any component of the charging material must NOT be able to release toxic gases.

 	 <b>DANGER</b>
	<p><b>Explosion or implosion hazard.</b></p> <p><b>Danger of poisoning.</b></p> <p><b>Danger of death.</b></p> <ul style="list-style-type: none"> <li>⊘ Do NOT introduce any substance combustible or explosive at working temperature into the chamber, in particular no energy sources such as batteries or lithium-ion batteries.</li> <li>⊘ NO explosive dust or air-solvent mixture in the inner chamber.</li> <li>⊘ Do NOT introduce any substance which could lead to release of toxic gases.</li> </ul>

**Other applications are not approved.**

	Observing the instructions in this operating manual and conducting regular maintenance work (chap. 24) is part of the intended use.
--	---

**The chambers are not classified as medical devices as defined by the Medical Device Directive 93/42/EEC.**

	Due to the special demands of the Medical Device Directive (MDD), these ovens are not qualified for sterilization of medical devices as defined by the directive 93/42/EWG.
---	---

	<b>WARNING:</b> If customer should use a BINDER chamber running in non-supervised continuous operation, we strongly recommend in case of inclusion of irrecoverable specimen or samples to split such specimen or samples and store them in at least two chambers, if this is feasible.
---	---

	Always use proper protective equipment (clothing, gloves, safety glasses, etc.). Always follow good hygienic practices according to GLP/SOP protocols. Each individual operating the chamber is responsible for his or her own safety
---	---

	The charging material shall not contain any corrosive ingredients that may damage the machine components made of stainless steel, aluminum, and copper. Such ingredients include in particular acids and halides. Any corrosive damage caused by such ingredients is excluded from liability by BINDER GmbH.
---	--

In case of foreseeable use of the device there is no risk for the user through the integration of the chamber into systems or by special environmental or operating conditions in the sense of EN 61010-1:2010. For this, the intended use of the chamber and all its connections must be observed.

## 1.9 Operating instructions

Depending on the application and location of the chamber, the operator of the chamber must provide the relevant information for safe operation of the chamber in a set of operating instructions.



Keep these operating instructions with the chamber at all times in a place where they are clearly visible. They must be comprehensible and written in the language of the employees.

## 1.10 Measures to prevent accidents

The manufacturer took the following measures to prevent dangers:

- **Indications on the type plate**  
See operating manual chap. 1.4.
- **Operating manual**  
An operating manual is available for each chamber.
- **Overtemperature monitoring**  
The chamber is equipped with a temperature display, which can be read from outside.  
The chamber is equipped with an additional safety controller (temperature safety device class 3.1 acc. to DIN 12880:2007). Visual and audible (buzzer) signals indicate temperature exceeding.
- **Safety, measurement, and control equipment**  
The safety, measuring, and control equipment is easily accessible.
- **Electrostatic charge**  
The interior parts are grounded.
- **Non-ionizing radiation**  
Non-ionizing radiation is not intentionally produced, but released only for technical reasons by electrical equipment (e.g. power cables). The machine is equipped with no permanent magnets. If persons with active implants (e.g. pacemakers, defibrillators) keep a safe distance (distance of field source to implant) of 30 cm, an influence of these implants can be excluded with high probability.
- **Protection against touchable surfaces**  
Tested according to EN ISO 13732-1:2008.
- **Floors**  
See operating manual chap. 3.4 for correct installation
- **Cleaning**  
See operating manual chap. 22.1.

## 2. Chamber description

The CO<sub>2</sub> incubators C / C-UL series were produced with great care using the latest tools for development and production. They can be operated in a temperature range from 6 °C / 10.8 °F above ambient temperature up to +50 °C / 122 °F and a CO<sub>2</sub> range of 0 vol.-% up to 20 vol.-%. The chambers are equipped with a microprocessor controller for temperature and CO<sub>2</sub> levels and a digital display accurate to one-tenth of a degree resp. 0.1 vol.-%. They are available in different voltages.

**Material:** The inner chamber, the pre-heating chamber and the inside of the doors are all made of stainless steel V2A (German material no. 1.4301, US equivalent AISI 304). The inner surfaces are smooth and therefore easy to clean. The inner chamber is deep-drawn from one piece, polished (suitable for pharmaceutical applications) and has no welds or inaccessible corners. The hinges and the seal of the inner glass door are glued from the outside to aid cleaning of the inner chamber. When operating the chamber at high temperatures (sterilization), the impact of the oxygen in the air may cause discoloration of the metallic surfaces (yellowish-brown or blue) by natural oxidation processes. These colorations are harmless and will in no way impair the function or quality of the chamber.

The perforated shelves and the shelf holder are also made of stainless steel (German material no. 1.4016, US equivalent AISI 430). You can insert a maximum of 8 shelves. The shelf holder is demountable without any tool. In this way, you can clean it hygienically in every laboratory dishwasher before hot-air sterilization.

The housing is RAL 7035 powder-coated. All corners and edges are also completely coated. The standard chamber door is hinged right. The chamber is optionally available with the door hinged left.

**Sterilization:** The heating system of the chamber permits hot-air auto-sterilization at 190 °C / 374 °F. Thus, a temperature of at least 180 °C / 356 °F is maintained on all internal surfaces, resulting in sterilization of the entire inner chamber.

**Safety:** Thanks to the standard safety device (class 3.1 according to DIN 12880:2007), the set temperature is maintained in case of failure.

An error diagnostics system monitors the chamber functions and generates audible and visual warning and alarm messages. The door is monitored for being closed.

The controller provides access control by combining password protection with different authorization levels.

**CO<sub>2</sub> system:** A highly precise, drift-free CO<sub>2</sub> infrared measuring system in combination with the permanent mixture of CO<sub>2</sub> gas through a special proprietary gas mixing head developed by BINDER allows precise and constant CO<sub>2</sub> concentrations for long periods. This creates optimum growth conditions for cultures. The gas enters the chamber via a fine filter (aseptic filter) with a high filtration efficiency that also filters the smallest particles.

The CO<sub>2</sub> sensor can be removed from the inner chamber by hand and cleaned with suitable detergents if needed.

Fast reaction times, maximum accuracy and selectivity characterize the CO<sub>2</sub> measuring procedure of the chamber. The accuracy of the CO<sub>2</sub> measuring system is based on an infrared measuring cell with NDIR (non-dispersive infrared) sensor, which continuously regulates to a reference value. Therefore, disturbance variables and aging phenomena in the measuring system are almost completely eliminated, so that this measuring system, in contrast to other measuring procedures, remains practically drift-free between calibrations and is entirely selective for CO<sub>2</sub>.

The CO<sub>2</sub> measuring cell contains a measuring section inside, in which the absorption of infrared light depends on the number of CO<sub>2</sub> molecules in the beam path. This number of CO<sub>2</sub> molecules changes with the ambient pressure in relation to a constant volume. The distances between the molecules are consequently pressure-dependent. The collision frequency of the IR-beam with CO<sub>2</sub> molecules increases therefore by increasing pressure. For this reason, the ambient pressure must be compensated in order to correct the display reading of the CO<sub>2</sub> concentration in vol.-%. This is achieved by entering the altitude of the site above the sea (chap. 6.4).

**Controller:** The efficient RD4 chamber controller is equipped with a multitude of operating functions, in addition to recorder and alarm functions. Set-point entry is easily accomplished accurate to one-tenth of a degree resp. 0.1 vol.-% directly via the chamber controller and is also possible directly with a computer via Intranet in connection with the APT-COM™ 4 Multi Management Software (option, chap. 20.4). The controller provides password protection for the setting menus. An error diagnostics system generates audible and visual alarm messages.

**Data monitoring and recording:** The chamber is regularly equipped with a zero-voltage relay alarm output (chap. 15.5) and optionally with analog outputs (chap. 20.6) for integration into customer systems.

The chamber is regularly equipped with an Ethernet interface for computer communication, enabling monitoring via a network. The BINDER APT-COM™ 4 Multi Management Software (option, chap. 20.4) permits networking of up to 100 chambers and connection to a computer, as well as recording and representing temperature and CO<sub>2</sub> data.

A data logger independent from the chamber controller (option, chap. 20.5) serves to independently record the temperature values, data given out in compliance with FDA guideline 21 CFR part 11.

## 2.1 Chamber overview

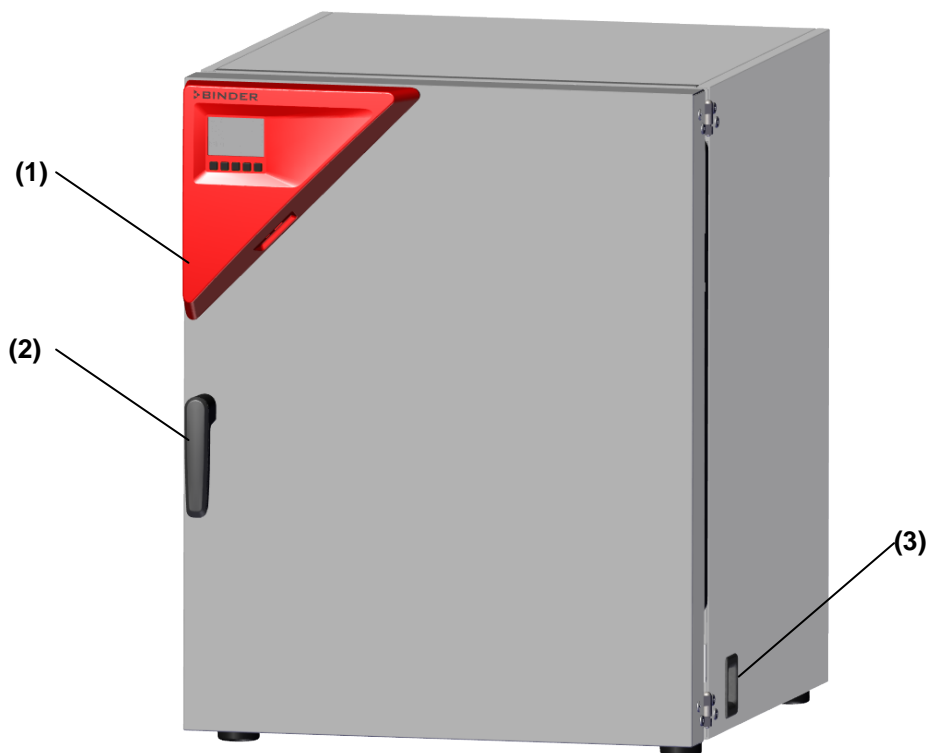

Figure 5: CO<sub>2</sub> incubator C / C-UL (example C 170), closed

- (1) Triangle instrument panel with RD4 controller for temperature and CO<sub>2</sub>
- (2) Door handle
- (3) Main power switch



## 2.2 Inner chamber

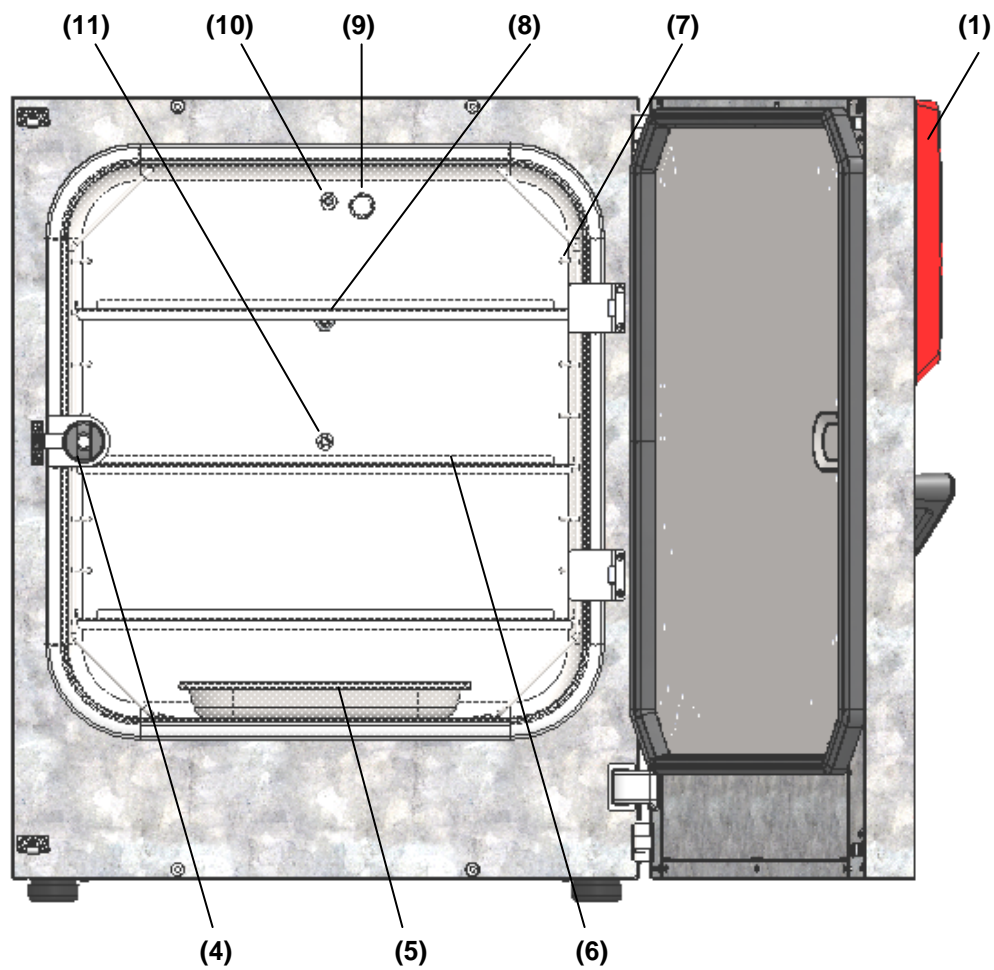

Figure 6: CO<sub>2</sub> incubator C / C-UL (example C 170), outer door open

- (1) Triangle instrument panel with RD4 controller for temperature and CO<sub>2</sub>
- (4) Glass door handle
- (5) Water pan
- (6) Shelves
- (7) Shelf holder
- (8) Pt 100 temperature sensor
- (9) CO<sub>2</sub> sensor
- (10) Gas mixing head for CO<sub>2</sub>
- (11) Silicone measuring port in the glass door

## 2.3 Connection panel on the rear of the chamber

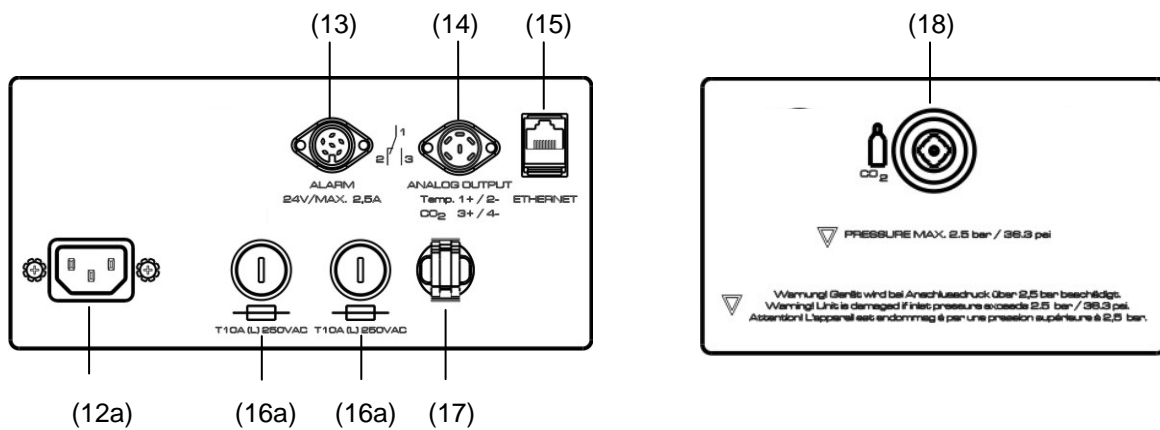

Figure 7: Rear control panel C with options

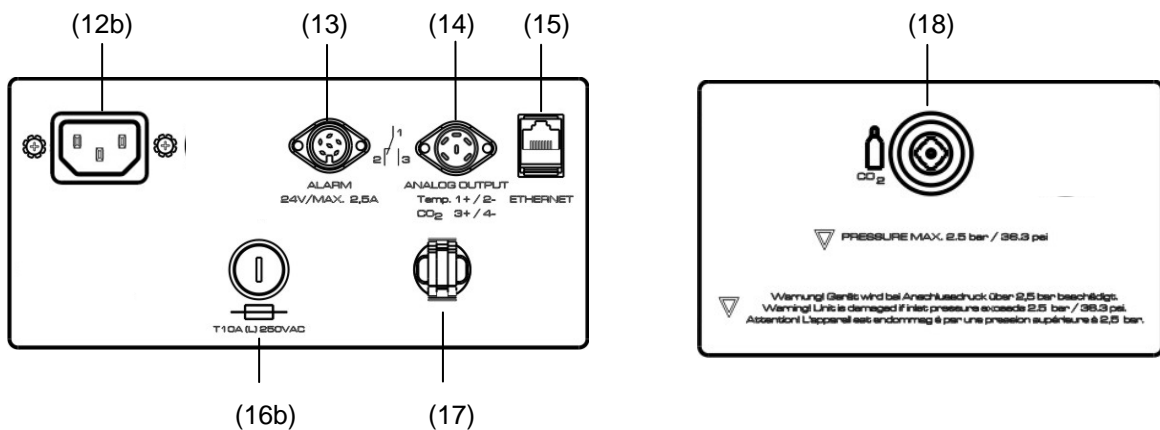

Figure 8: Rear control panel C-UL with options

- (12a) Socket for IEC connector plug / power cable 230 V AC for C
- (12b) Socket for IEC connector plug / power cable 100-120 V AC for C-UL
- (13) DIN-socket for zero-voltage relay alarm outputs
- (14) DIN socket for analog outputs 4-20 mA (available by BINDER INDIVIDUAL Customized Solutions)
- (15) Ethernet interface for computer communication
- (16a) Miniature fuse T10 A (L) 250 V AC for C
- (16b) Miniature fuse T12,5 A (L) 250 V AV for C-UL
- (17) Strain relief for power cable
- (18) Quick acting closure socket for CO<sub>2</sub>

## 2.4 Chamber doors

The outer chamber door is equipped with a heater on its inner side. The door must be closed while the chamber is operating normally in order to ensure stable climatic conditions in the inner chamber.

An additional glass door enables viewing of the samples without disturbing the temperature in the interior and contaminating the samples sealing the interior of the chamber.

When the outer door is open, the CO<sub>2</sub> intake valve automatically closes.

	<p>Delay time for the temperature and CO<sub>2</sub> tolerance range alarm :</p> <p>After closing the outer door, the tolerance range alarm is turned off for a programmable delay time. This prevents alarms being constantly triggered during the unstable operating phase after opening the outer door.</p>
---	--

## 2.5 Instrument panel

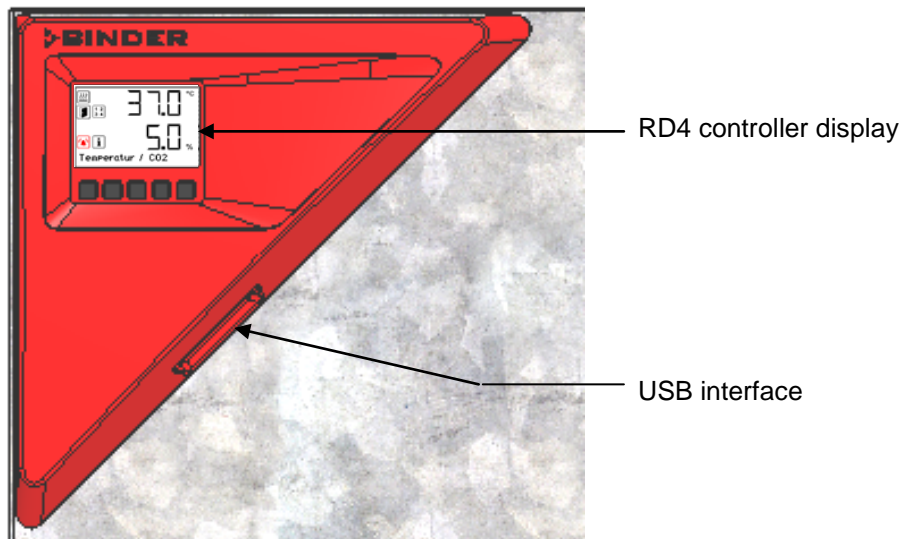

Figure 9: Instrument panel with RD4 controller and USB interface

### 3. Completeness of delivery, transportation, storage, and installation

#### 3.1 Unpacking, and checking equipment and completeness of delivery





After unpacking, please check the chamber and its optional accessories, if any, based on the delivery receipt for completeness and for transportation damage. Inform the carrier immediately if transportation damage has occurred.

The final tests of the manufacturer may have caused traces of the shelves on the inner surfaces. This has no impact on the function and performance of the chamber.

Please remove any transportation protection devices and adhesives in/on the chamber and on the doors and remove the operating manuals and accessory equipment.

For transport purpose, a silica gel bag for drying purpose was added. Do not eat! Do not open the silica gel bag and dispose of it with normal waste.

	Remove any protective lamination sheet on the inner metal surfaces prior to commissioning.
---	--

	 <b>CAUTION</b>
	<p><b>Sliding or tilting of the chamber.</b>  <b>Damage to the chamber.</b>  <b>Risk of injury by lifting heavy loads.</b></p> <ul style="list-style-type: none"> <li>⊘ Do NOT lift or transport the chamber using the door handle or the door.</li> <li>➤ Lift the chamber from the pallet at the four lower corners with the aid of four people.</li> </ul>
	

If you need to return the chamber, please use the original packing and observe the guidelines for safe lifting and transportation (chap. 3.2).

For disposal of the transport packing, see chap. 25.1.

#### **Note on second-hand chambers (Ex-Demo-Units):**





Second-hand chambers are chambers that were used for a short time for tests or exhibitions. They are thoroughly tested before resale. BINDER ensures that the chamber is technically sound and will work flawlessly.

Second-hand chambers are marked with a sticker on the chamber door. Please remove the sticker before commissioning the chamber.

### 3.2 Guidelines for safe lifting and transportation

After operation, please observe the guidelines for temporarily decommissioning the chamber (chap. 25.2).

Empty the water pan before moving the incubator. In case of any spilling of the contents, shut down the incubator and dry it out carefully and completely

  	 <b>CAUTION</b>
<p><b>Sliding or tilting the chamber.</b>  <b>Damage to the chamber.</b>  <b>Risk of injury by lifting heavy loads.</b></p> <ul style="list-style-type: none"> <li>➤ Transport the chamber in its original packaging only.</li> <li>➤ Secure the CO<sub>2</sub> incubator with transport straps for transport.</li> <li>⊘ Do NOT lift or transport the chamber using the door handle or the door.</li> <li>➤ Lift the chamber at the four lower corners with the aid of 4 people and place it on a rolling pallet.</li> <li>➤ Move the chamber to the desired location and lift it from the rolling pallet with the aid of four people.</li> </ul>	

- Permissible ambient temperature range for transport: -10 °C / 14°F to +60 °C / 140°F.

You can order transport packing and rolling pallets for transportation purposes from BINDER Service.

### 3.3 Storage

Intermediate storage of the chamber is possible in a closed and dry room. Observe the guidelines for temporary decommissioning (chap. 25.2).

- Permissible ambient temperature range for storage: -10 °C / 14°F to +60 °C / 140°F.
- Permissible ambient humidity: max. 70% r.h., non-condensing

When after storage in a cold location you transfer the chamber to its warmer installation site, condensation may form in the inner chamber, on the housing or in the sensor compartment of the CO<sub>2</sub> measurement. Before start-up, wait at least one hour until the CO<sub>2</sub> incubator has attained ambient temperature and is completely dry.

### 3.4 Location of installation and ambient conditions

#### Notes on the location of installation

Set up the chamber on a flat, even surface, free from vibration and in a well-ventilated, dry location. The chambers are designed for setting up inside a building (indoor use).

Freestanding chambers are suitable for installation on tables or on the optionally available stand. Note: The site of installation must be capable of supporting the chamber's weight (see technical data, chap. 27.4).

Align the chamber using a spirit level to ensure even covering of the cell-cultures with the medium. For this purpose, manually adjust the four incubator feet.

In order to avoid contamination, never place the chamber directly on the floor.



	<b>CAUTION</b>
	<p><b>Danger of overheating.</b> <b>Damage to the chamber.</b></p> <ul style="list-style-type: none"> <li>⊘ Do NOT set up chambers in non-ventilated recesses.</li> <li>➤ Ensure sufficient ventilation for dispersal of the heat.</li> </ul>

To completely separate the chamber from the power supply, you must disconnect the power plug. Install the chamber in a way that the power plug is easily accessible and can be easily pulled in case of danger.

Avoid any conductive dust in the ambience according to the chamber layout complying with pollution degree 2 (IEC 61010-1).

For the user there is no risk of temporary overvoltages in the sense of EN 61010-1:2010.

Do not install or operate the chamber in potentially explosive areas.

	 <b>DANGER</b>
	<p><b>Explosion hazard.</b> <b>Danger of death.</b></p> <ul style="list-style-type: none"> <li>⊘ Do NOT operate the chamber in potentially explosive areas.</li> <li>⊘ KEEP explosive dust or air-solvent mixtures AWAY from the vicinity of the chamber.</li> </ul>

#### Ambient conditions

- Permissible ambient temperature range for operation: +18 °C / 64.4 °F up to +30 °C / 86 °F. At elevated ambient temperature values, fluctuations in temperature can occur.
- Ideal ambient temperature: by at least 6 °C / 10.8 °F below the intended working temperature. E.g., working temperature 37 °C / 98.6 °F – resulting permitted ambient temperature 31 °C / 87.8 °F and lower

In the event of working temperatures of less than 6 °C / 10.8 °F above the ambient temperature, the set point can be exceeded.

Do not place the chamber directly below the air outlet of an air conditioner.



	<p>The ambient temperature should not be substantially higher than the indicated ambient temperature of +22 °C +/- 3 °C / 71.6 °F ± 5.4 °F to which the specified technical data relate. For other ambient conditions, deviations from the indicated data are possible.</p>
---	---

	<p>Avoid direct solar radiation on the chamber. Avoid strong drafts, e.g. by air conditioning.</p>
---	--

- Permissible ambient humidity: 70% r.h. max., non-condensing.
- Installation height: max. 2000 m / 6562 ft. above sea level. After the incubator has been turned on for the first time, enter the altitude of the site above sea level into the RD4 controller (chap. 6.4).
- Wall distances: rear 100 mm / 3.94 in, sides 50 mm / 1.97 in.

## Notes on handling carbon dioxide (CO<sub>2</sub>)

Carbon dioxide (CO<sub>2</sub>) in high concentrations is hazardous to health. It is colorless and almost odorless and therefore practically imperceptible. Vent out any CO<sub>2</sub> gas that may escape via good room ventilation or a suitable connection to an exhaust system. We recommend installing a CO<sub>2</sub> warning system.

	 <b>WARNING</b>
	<p><b>High concentration of CO<sub>2</sub> (&gt; 4 Vol.-%).</b>  <b>Danger of death by suffocation.</b>  <b>Danger of poisoning.</b></p> <ul style="list-style-type: none"> <li>⊘ Do NOT set up chambers in non-ventilated recesses.</li> <li>➤ Ensure technical ventilation measures.</li> <li>➤ Observe the relevant regulations for handling CO<sub>2</sub>.</li> </ul>

Observe the **occupational exposure limit OEL** for CO<sub>2</sub> set by the national authorities (formerly maximum permitted workplace concentration). Check compliance when operating all chambers located in the room.

- OEL for Germany: 5000 ml/m<sup>3</sup> (ppm) = 0,5 Vol.-%
- CO<sub>2</sub> lost with each door opening: about 16.4 g, i.e. 0.0084 cubic meters / 0.296 cubic feet (under normal pressure)
- CO<sub>2</sub> lost during 12h at 5 vol.-% without door opening: approx. < 2 g, i.e. 0.001 cubic meters / 0.035 cubic feet (under normal pressure 1013 mbar / 14.7 psi)

### An example of how to evaluate laboratory volume and air change rate:

**Question:** Is an air change rate of 1/h sufficient for a lab with a volume of 100 cubic meters / 3,531.5 cubic feet with 10 CO<sub>2</sub> incubators, opened 4 times per hour?

**Calculation:** CO<sub>2</sub> concentration = CO<sub>2</sub> lost by door opening, multiplied by 10 chambers, multiplied by 4 door openings per hour, divided by lab volume

0.0084 cubic meters x 10 x 4 div. 100 cubic meters = 0.00336, i.e. 0.336% or 3360 ppm.

0.296 cubic feet x 10 x 4 div. 3,531.5 cubic feet = 0.00336, i.e. 0.336% or 3360 ppm.

**Result:** The maximum permissible value of 5000 ppm is not exceeded under these operation conditions.

Even when CO<sub>2</sub> or systems operated with CO<sub>2</sub> are handled carefully and appropriately, a residual risk remains, which can lead to life-threatening situations under certain circumstances. Therefore we strongly recommend continuous monitoring of CO<sub>2</sub> concentration in the ambient air of the CO<sub>2</sub> incubator. It must be ensured permanently that the maximum permissible occupational exposure limit OEL for CO<sub>2</sub> (0.5 vol - % CO<sub>2</sub> for Germany) is not exceeded.

## 4. Installation and connections

### 4.1 Shelf holder and shelves

The shelf holder consists of two identical side parts. Insert them alongside the lateral walls of the inner chamber. They are fixed by cams on the bottom of the inner chamber. For assembly and disassembly, fold both side parts towards the middle.

Then you can insert the shelves into the shelf holder. Hold the shelf straight and then insert it so it will go smoothly inside the chamber.

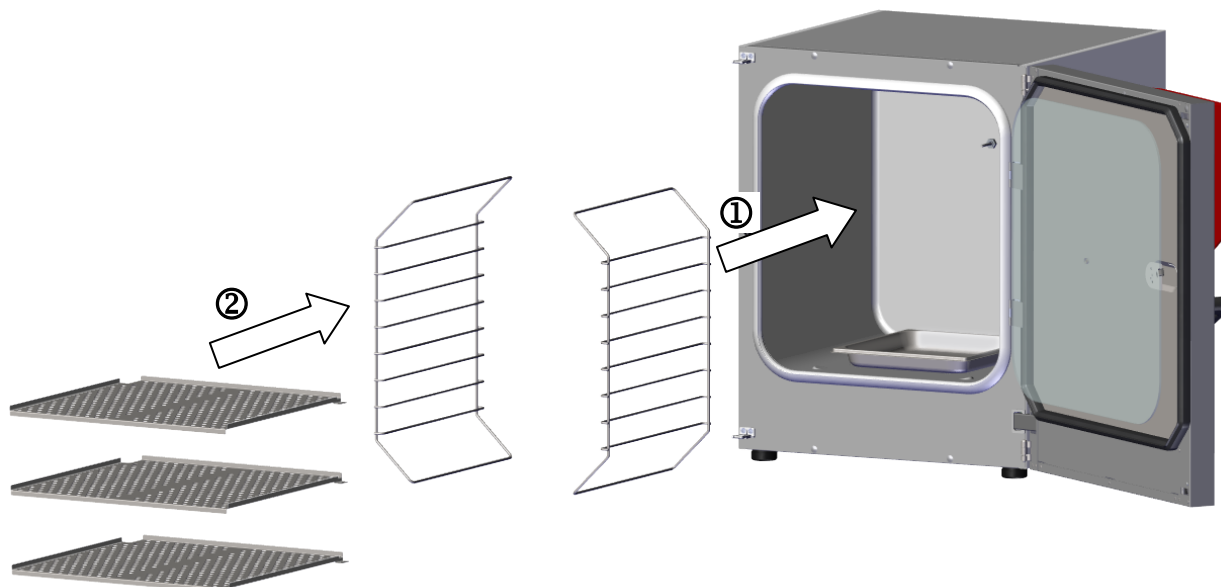

Figure 10: Installation of the shelves and shelf holder



If just one of the three supplied shelves shall be used in one of the three lower positions, we recommend inserting a supplementary shelf as high as possible into the shelf holder for stabilizing purpose.

To remove the shelf holder, remove the shelves first.

It is not possible to take out the shelf holder entirely together with the shelves.

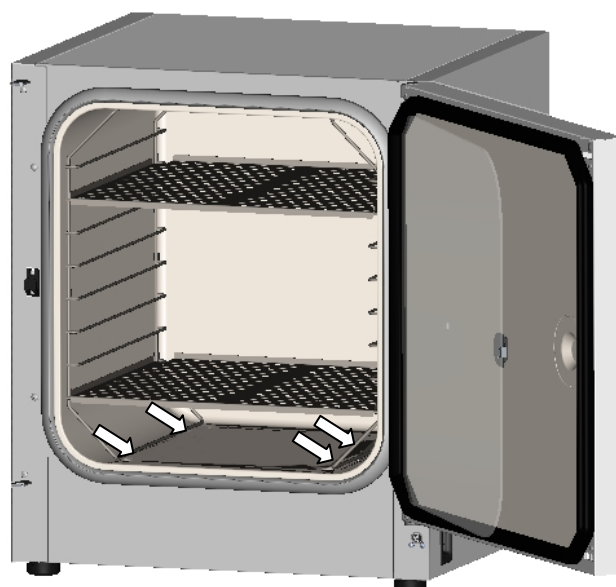

Figure 11: View of the interior with inserted shelves and the position of the cams to fix the shelf holder



**Permitted shelf loads:**

Maximum load on one single shelf: 10 kg / 22 lb

Maximum total load on all shelves: 40 kg / 88 lb

**4.2 CO<sub>2</sub> sensor**

**4.2.1 Connecting the CO<sub>2</sub> sensor**

Turn off the chamber. Open the door of the inner chamber and plug the CO<sub>2</sub> sensor (4) into the permanently installed holding tube located in the upper part of the rear of the inner chamber.



Figure 12: Plugged-in CO<sub>2</sub> sensor (right) and gas mixing head for CO<sub>2</sub>

The sensor must click in correctly and sit tightly in the connection socket.

	<b>CAUTION</b>
	<p><b>Connecting or removing the CO<sub>2</sub> sensor during operation.</b>  <b>Damage to the CO<sub>2</sub> sensor.</b></p> <ul style="list-style-type: none"> <li>➤ Connect or remove the CO<sub>2</sub> sensor only with the chamber turned off.</li> </ul>

**4.2.2 General notes**

Connect or remove the CO<sub>2</sub> sensor without rotating and only when the incubator is turned off. Remove the CO<sub>2</sub> sensor before removing or replacing its filter cap. The PTFE filter of the CO<sub>2</sub> sensor prevents dirt and humidity from intruding into the measuring cell. It is available as a spare part. Replace it whenever it is damaged or soiled.

	<p>The accuracy of the indicated values of CO<sub>2</sub> depends on the ambient air pressure (approx. 0.08 vol.-% per 10 mbar / 0.15 psi). In order to compensate this effect when measuring the CO<sub>2</sub> concentration, the altitude of the installation site above sea level can be entered into the controller (chap. 6.4).</p>
---	---

**The CO<sub>2</sub> sensor is temperature resistant up to a maximum temperature of 60 °C / 140 °F.**

	<b>CAUTION</b>
	<p><b>Excess temperature.</b>  <b>Damage to the CO<sub>2</sub> sensor.</b></p> <ul style="list-style-type: none"> <li>⊘ Do NOT autoclave the CO<sub>2</sub> Sensor.</li> <li>⊘ Do NOT expose the CO<sub>2</sub> sensor to hot-air sterilization.</li> </ul>

The CO<sub>2</sub> sensor head was especially adjusted for the specific chamber. To avoid confusion, an adhesive label with a serial number is adhered to the sensor head. When exchanging the sensor, you must repeat the CO<sub>2</sub> adjustment.

	<b>CAUTION</b>
	<p><b>Different CO<sub>2</sub> sensor.</b> <b>Invalid calibration.</b></p> <ul style="list-style-type: none"> <li>⊘ Do NOT change the CO<sub>2</sub> sensor head.</li> <li>➤ Note down the serial number of the CO<sub>2</sub> sensor.</li> </ul>

Avoid strong shocks when handling the CO<sub>2</sub> sensor.

	<b>CAUTION</b>
	<p><b>Shocks of the CO<sub>2</sub> sensor.</b> <b>Damage to the CO<sub>2</sub> sensor.</b></p> <ul style="list-style-type: none"> <li>⊘ Avoid strong shocks of the CO<sub>2</sub> sensor (by putting it down hard, or dropping).</li> </ul>

### 4.3 Water pan

The water pan permits high humidity without condensation on the inner walls of the CO<sub>2</sub> incubator.

Place the water pan in central position on the bottom of the inner chamber. Place the water pan with its narrow side centrally between the front cams on the bottom of the inner chamber.

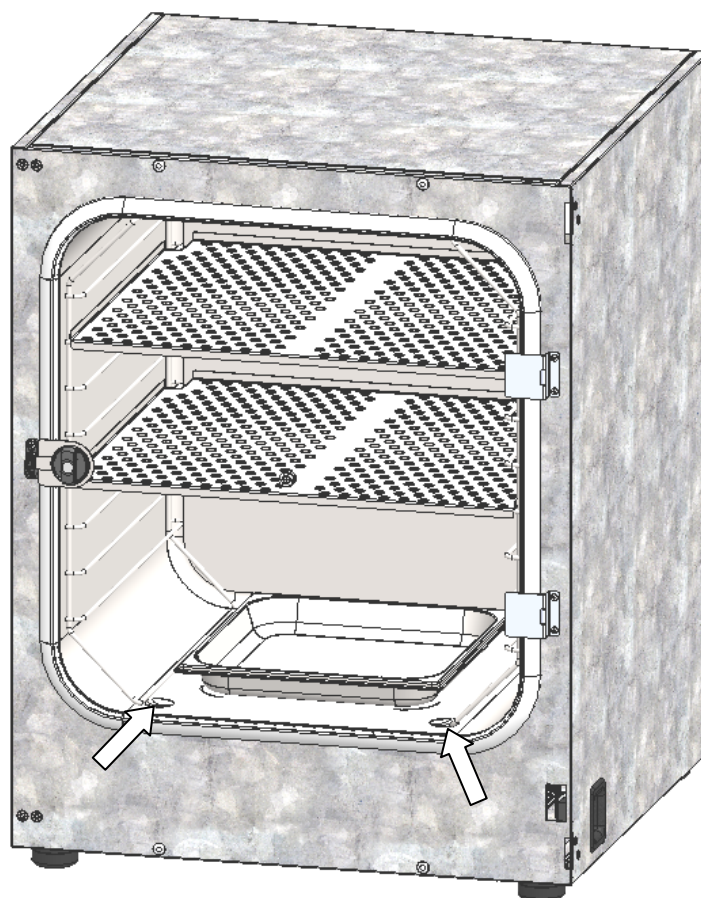

Figure 13: Position of the water pan centrally between the front cams (arrows)

Make sure that the water pan has firm contact with the inner chamber bottom and rests tightly on it.

Fill the water pan with 1 liter of distilled, sterilized water.

We recommend cleaning (chap. 22.1) and refilling the pans 2 to 3 times a week. For evacuation, remove the water pan.

We recommend using distilled, sterile water to achieve optimum growth results. Any corrosive damage that may arise following use of water of different quality or by additives is excluded from the liability agreement.



If required, you can add microbiologically inhibiting substances such as copper chips, copper sulphate or ethylene diamine tetra-vinegar acid (EDTA) in a concentration of 1 to 5 mmol/l.

Empty the water pan before moving the incubator. In case of the contents spilling, immediately shut down the incubator and dry it carefully and completely.



#### 4.4 Gas connection

	<p>General information for safe handling of gas cylinders:</p> <ul style="list-style-type: none"> <li>• Store and use gas cylinders only in well ventilated areas.</li> <li>• Open the gas cylinder valve slowly to avoid pressure surges</li> <li>• Secure gas cylinders during storage and use against falling (chaining).</li> <li>• Transport gas cylinders with a cylinder cart, do not carry, roll, or throw them</li> <li>• Always close the valve even with apparently empty cylinders; screw on the cap when not in use. Return gas cylinders with the valve closed</li> <li>• Do not open gas cylinders by force. Mark them when damaged</li> <li>• Protect gas cylinders against fire, e.g. do not store together with flammable liquids</li> <li>• Observe relevant regulations for dealing with gas cylinders.</li> </ul>
---	--

Secure the gas cylinders against falling and other mechanical damage.

	 <b>WARNING</b>
	<p><b>Safety valve tearing off.</b>  <b>Sudden release of the stored pressure energy.</b>  <b>Risk of injury.</b></p> <ul style="list-style-type: none"> <li>➤ Secure gas cylinders against falling (chaining).</li> <li>➤ Transport gas cylinders with a cylinder cart.</li> </ul>



The valve of the gas cylinder **always** must be closed before screwing on or unscrewing the gas hose.

	 <b>WARNING</b>
	<p><b>Opening the cylinder valve when the cylinder is not connected.</b>  <b>Sudden release of the stored pressure energy.</b>  <b>Risk of injury.</b></p> <ul style="list-style-type: none"> <li>➤ Close the gas cylinder valve before connecting or removing the gas hose.</li> </ul>

	<p>After connecting the gas cylinder, check all gas connections for leaks (e.g. with leak spray or diluted soap solution).</p>
---	--

#### 4.4.1 Connecting the CO<sub>2</sub> gas cylinder

Carbon dioxide (CO<sub>2</sub>) in high concentrations is hazardous to health. It is colorless and almost odorless and therefore practically imperceptible. Vent out any CO<sub>2</sub> gas that may escape via good room ventilation or a suitable connection to an exhaust system. We recommend installing a CO<sub>2</sub> warning system.

	 <b>WARNING</b>
	<p><b>High concentration of CO<sub>2</sub> (&gt; 4 Vol.-%).</b>  <b>Danger of death by suffocation.</b>  <b>Danger of poisoning.</b></p> <ul style="list-style-type: none"> <li>∅ Do NOT set up chambers in non-ventilated recesses.</li> <li>➤ Ensure technical ventilation measures.</li> <li>➤ Observe the relevant regulations for handling CO<sub>2</sub>.</li> </ul>

	The CO <sub>2</sub> gas necessary for operation must have a technical grade of 99.5 %.
---	--

	The gas connections must be established by qualified personnel who are trained in handling the respective gases and familiar with the required safety measures.
---	---

The following steps are required:

##### Ensuring the correct CO<sub>2</sub> output pressure

	A gas supply pressure above 2.5 bar / 36 <i>psi</i> will result in chamber damage.
---	--

Use a pressure reducer and make sure to avoid any excessive outlet pressure when connecting the gas hose to the incubator.

The real outlet pressure of gas cylinders, sets of gas cylinders or central gas supplies am on the second manometer must **not** exceed 2.5 bar / 36 *psi*.

	<b>CAUTION</b>
	<p><b>Excessive outlet pressure &gt; 2.5 bar / 36 <i>psi</i>.</b>  <b>Damage to the chamber.</b></p> <ul style="list-style-type: none"> <li>∅ The outlet pressure must NOT exceed the indicated value of 2.5 bar / 36 <i>psi</i>.</li> <li>➤ Before connecting, check the outlet pressure on the pressure reducer of the cylinder.</li> <li>➤ Adjust the outlet pressure to 2.0 bar / 29 <i>psi</i> above the ambient pressure.</li> </ul>

Observe the correct outlet pressure also when replacing the gas cylinders.

##### Establishing the connection to the incubator

Connect the supplied gas hose (internal diameter 6 mm / 0.24 *inches*) to the pressure reducer of the gas cylinders or central gas supply and secure the connection with the supplied hose clamp.

Connect the pre-assembled hose nozzle of the gas hose to the quick acting closure socket (14) DN 6 on the chamber rear, as described in chap. 4.4.2.

##### Leak test

After connecting the gas cylinder, check all gas connections for leaks (e.g. with leak spray or diluted soap solution).



The recovery times of the gas concentrations inside the chamber after opening the door are indicated in the technical data (chap. 27.4) and refer to a connection pressure of 2.0 bar / 29 *psi*. Decreasing supply pressure will result in longer recovery times.

**Conversion table for gas inlet pressures, bar – psi, see chap. 27.6.**

#### 4.4.2 Connecting the gas hose to the chamber rear

The gas hose, which will be used to establish the connection to a gas cylinder, is already attached to the hose nozzle and secured by a hose clamp. Plug the hose nozzle into the corresponding quick acting closure socket (a) located at the rear of the chamber. This quick acting closure socket is closed by a rubber cover (b).



Only use the supplied hose nozzle to connect to the quick acting closure socket. Otherwise, the quick acting closure socket may leak, and/or it may become impossible to connect the original hose nozzle. In this case, please contact BINDER Service.

Remove the rubber cover (b) by pulling it off.

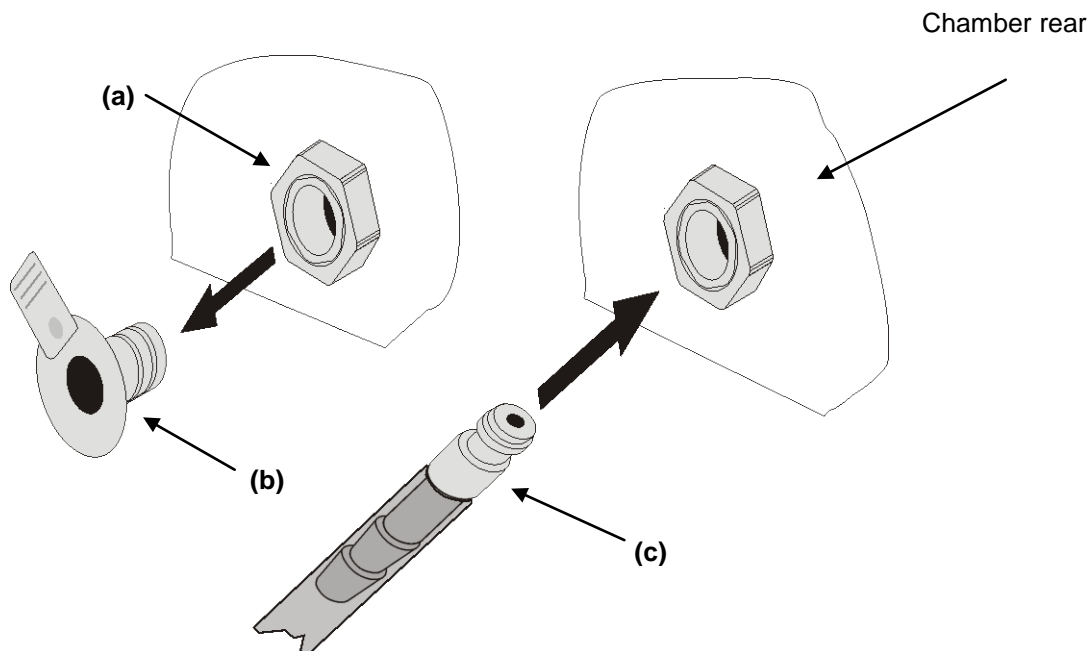
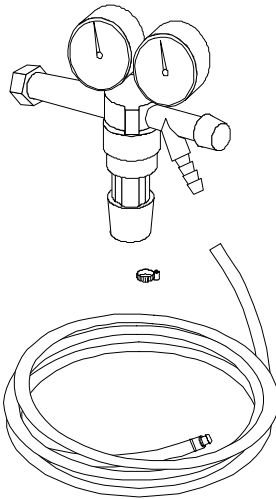

Figure 14: Connection of the hose lead to the gas cylinder

Now fit the hose nozzle (c) in the quick acting closure socket. To remove the connection, pull the hose nozzle off the quick acting closure socket.

#### 4.4.3 Gas cylinder connection kit (option)



The gas cylinder connection kit for CO<sub>2</sub> (Art. no. 8012-0014) includes the following parts for connecting a gas cylinder to the CO<sub>2</sub> incubator:

- Pressure reducer with manometers for cylinder pressure (high pressure gauge) and outlet pressure (low pressure gauge)
- 5 m pressure hose with pre-assembled hose nozzle for quick acting closure socket
- 1 hose clamp to connect the gas hose to the pressure reducer

The pressure reducer is also available as an individual accessory.

Figure 15: Gas cylinder connection kit



Instructions 7001-0249 included with the connection kit describe connecting and setting the gas cylinder connection kit.



### CAUTION

**Excessive outlet pressure > 2.5 bar / 36 psi.**

**Damage to the chamber.**

- ⊘ The outlet pressure must NOT exceed the indicated value of 2.5 bar / 36 psi.
- Before connecting, check the outlet pressure on the pressure reducer of the cylinder.
- Adjust the outlet pressure to 2.0 bar / 29 psi above the ambient pressure.



The gas connections must be established by qualified personnel who are trained in handling the respective gases and familiar with the required safety measures.

## 4.5 Electrical connection

The chambers are supplied ready for connection. They come with an IEC connector plug.

Model	Power plug	Nominal voltage +/- 10% at the indicated power frequency	Current type	Chamber fuse
C 170	Shock-proof plug	200-230 V at 50 Hz 200-230 V at 60 Hz	1N~	10 A
C 170-UL	NEMA 5-20P	100-120 V at 50 Hz 100-120 V at 60 Hz	1N~	16 A

- The domestic socket must also provide a protective conductor. Make sure that the connection of the protective conductor of the domestic installations to the chamber's protective conductor meets the latest technology. The protective conductors of the socket and plug must be compatible!
- Only use original connection cables from BINDER.
- Prior to connection and start-up, check the power supply voltage. Compare the values to the specified data located on the chamber's type plate (centrally located at the bottom of the left-hand side of the chamber, see chap. 1.4)
- When connecting, please observe the regulations specified by the local electricity supply company and as well as the VDE directives (for Germany). We recommend the use of a residual current circuit breaker.
- Pollution degree (acc. to IEC 61010-1): 2
- Over-voltage category (acc. to IEC 61010-1): II

	<b>CAUTION</b>
	<p><b>Danger of incorrect power supply voltage.</b> Damage to the equipment.</p> <ul style="list-style-type: none"> <li>➤ Check the power supply voltage before connection and start-up.</li> <li>➤ Compare the power supply voltage with the data indicated on the type plate.</li> </ul>

See also electrical data (chap. 27.4).

	<p>To completely separate the chamber from the power supply, you must disconnect the power plug. Install the chamber in a way that the power plug is easily accessible and can be easily pulled in case of danger.</p>
---	--

## 5. Functional overview of the RD4 chamber controller

The RD4 chamber controller controls following parameters inside the chamber:

- Temperature in °C or °F (range 6 °C / 10.8 °F above ambient temperature up to 50 °C / 122 °F)
- Carbon dioxide concentration in vol.-% (range 0 vol.-% up to 20 vol.-%)

You can enter the desired set point values in the “**Set points**” menu directly at the controller or use the APT-COM™ 4 Multi Management Software (option) specially developed by BINDER.

The controller offers various notifications and alarm messages with visual and audible indication. All controller setting remain valid until the next manual change. They are stored also after turning off the chamber.

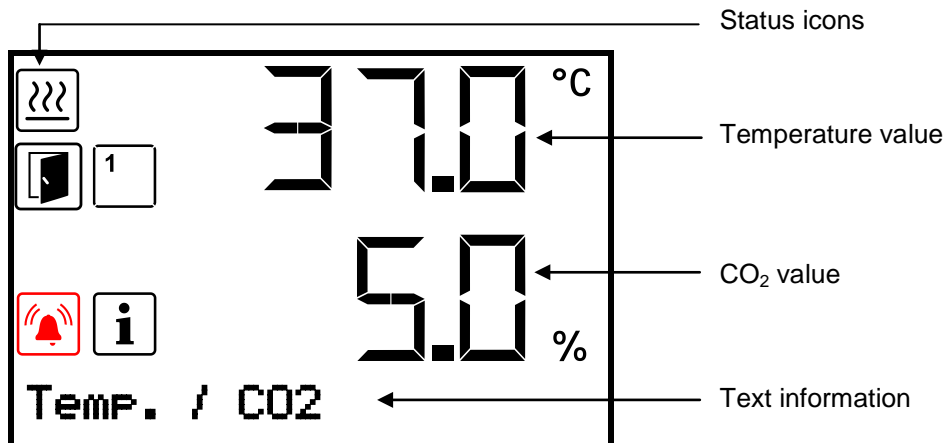













Figure 16: Normal display of the RD4 controller (sample values)

### Status icons in the controller display

Icon	Signification	Icon	Signification
	Heating active		Collective alarm
	Door open		Hot air sterilization running
	Do not open the door!		Display of activated special controller functions: 1 = Idle mode 2 = CO <sub>2</sub> control deactivated
	Information		

### Functional controller keys

Icon	Signification	Function
	<b>Arrow-up button</b>	<ul style="list-style-type: none"> <li>• Navigate between menus, submenus, other functions</li> <li>• In the setting menu: change setting, increase value</li> </ul>
	<b>Arrow-down button</b>	<ul style="list-style-type: none"> <li>• Navigate between menus, submenus, other functions</li> <li>• In the setting menu: change setting, decrease value</li> </ul>
	<b>OK button</b>	<ul style="list-style-type: none"> <li>• Select menu, submenu, function</li> <li>• In the setting menu: Confirm entry</li> </ul>
	<b>Back button</b>	Back to previous menu level
	<b>Standby button</b>	No function



## 5.1 Menu structure of the controller and access levels

Starting from Normal display, navigate between the menus with the **arrow buttons**.

With the **OK button** you enter the setting of further subordinate menu functions.

With the **Back button** you go back to the previous function and finally back to Normal display.

The available functions depend on the current dependent on the current **authorization** "User", "Admin" or "Service", for which the entry of a password may be required, depending on the setting.

You can set passwords for different access levels:

- **User:** The password enables access to the standard operating functions. Factory setting is 00 00 (no password assigned).
- **Admin:** The password enables access to advanced controller functions and settings. Factory setting is 00 01.
- **Service:** The password enables access to all controller functions (for BINDER Service only).

As soon as a password has been assigned, access to the respective functions is blocked and only available after entering the correct password.

Menu	Required access level	Functions
<b>Sterilization</b>	"User"	<ul style="list-style-type: none"> <li>• Activating/deactivating the sterilization</li> </ul>
<b>Setpoints</b>	"User"	<ul style="list-style-type: none"> <li>• Temperature and CO<sub>2</sub> set-point setting</li> <li>• Change to Idle mode</li> <li>• Turning on / off CO<sub>2</sub> control</li> <li>• Setting the safety controller</li> </ul>
<b>Chamber info</b>	Any user	<ul style="list-style-type: none"> <li>• Configuration display (setup information, controller hardware and software, analog inputs)</li> <li>• Display of interface configuration (e.g. MAC address, IP address)</li> </ul>
<b>Settings</b>	"Admin"	<ul style="list-style-type: none"> <li>• General controller settings (date, time, menu language, temperature unit, display brightness...)</li> <li>• Network settings</li> <li>• Setting the data logger storage interval</li> <li>• Setting the altitude above sea level</li> <li>• Setting the tolerance range limits and delay time for door and tolerance range alarm</li> <li>• Password changing for User and Admin</li> </ul>
<b>Service</b>	"Service"	<ul style="list-style-type: none"> <li>• Configuration settings (only for BINDER Service)</li> <li>• Password changing for User and Admin</li> </ul>
<b>USB</b>	Export: Any user Import: "Admin"	<ul style="list-style-type: none"> <li>• Export of configuration, logger, and service data</li> <li>• Import of configuration data</li> </ul>

Unless noted otherwise, the figure in this manual show the functional range, which is available for the user with "Admin" authorization level

Note: When specifying the path to the respective function, the possibly required entry of a password is not listed

## 5.2 Performance during and after power failures and shut down

In the event of power failure, all controller functions are shut down. The gas inlet valves are closed so that no gas can escape into the ambient air. The zero-voltage relay alarm output (13) (chap. 15.4.1) is switched to alarm position indicating the alarm for the whole duration of the power failure.

After the power returns or after turning on the chamber, all functions return to the same status the chamber had before power failure. The set-points are immediately resumed.

If the chamber was in sterilization mode, the process is cancelled and the chamber continues normal operating mode with the original set points previously entered .



All settings and set point values remain in the memory during power failure after power off.

## 6. Start up

Check that the interior of the chamber is empty, including the trays and the water pan. If you do not know what the chamber was last used for, for hygiene purposes you should clean and disinfect or sterilize the interior (chap. 22).



**WARNING:** If customer should use a BINDER chamber running in non-supervised continuous operation, we strongly recommend in case of inclusion of irrecoverable specimen or samples to split such specimen or samples and store them in at least two chambers, if this is feasible.

Warming chambers may release odors in the first few days after commissioning. This is not a quality defect. To reduce odors quickly we recommend heating up the chamber to its nominal temperature for one day and in a well-ventilated location.

### 6.1 Turning on the chamber

Open the CO<sub>2</sub> supply's pressure reducer valve and set a CO<sub>2</sub> primary pressure of 2.0 bar / 29 *psi*.

After connecting the supply lines, turn on the chamber by the main power switch (2). The lit pilot lamp shows the chamber is ready for operation.

The controller shows normal display and controls the temperature and CO<sub>2</sub> to the last entered values.

After turning on the chamber for the first time, enter the altitude of the site above sea level into the controller (chap. 6.4).

## 6.2 Preset factory parameters

The chamber is supplied with the following basic preset parameters:

Parameter	Factory setting	Setting / modification
Temperature set point	37.0 °C / 98.6°F	chap. 7.1
CO <sub>2</sub> set point	5.0 vol.-%	chap. 7.2
Safety controller mode	"Offset"	chap. 11.2.1
Safety controller value	2.0 °C	chap. 11.2.2
Sterilization temperature set point	190 °C / 374 °F	fix
Installation height above sea level	650 m / 2132.54 ft	chap. 6.4
Temperature tolerance range	+/- 1.0 K	chap. 13.2
CO <sub>2</sub> tolerance range	+/- 1.0 vol.-%	chap. 13.3
Delay time for tolerance range alarms	10 min	chap. 13.1
Delay time for door open alarms	1 min	chap. 13.4
Password for "User" access level.	0	chap. 10.2.1
Password for "Admin" access level.	1	chap. 10.2.2
The following settings should only be modified by BINDER service:		
Humidity control	0 % r.h.	chap. 14.1
Door heating Offset value	3.0 °C	chap. 14.2
Adjustment factor of the heating power	12.0	chap. 14.3

## 6.3 Performance after turning on the chamber

During the equilibration phase of 2 hours after turning on the chamber, undefined temperature and CO<sub>2</sub> conditions occur within the chamber. During this phase, do not place any sample materials in the chamber.

	<b>CAUTION</b>
	<p><b>Danger of samples being destroyed.</b></p> <p>➤ Charge the chamber only after equilibration of temperature and CO<sub>2</sub>.</p>

If the function "Language selection at restart" has been activated (chap. 12.5, factory setting ON), the following settings are checked upon start up:

- **Menu language** (chap. 12.1):  
Use the **arrow buttons** to select the desired language, confirm with the **OK button**
- **Temperature unit** (chap. 12.2):  
Use the **arrow buttons** to select the desired temperature unit, confirm with the **OK button**.
- **Current date** (chap. 12.3), format DD MM YYYY:  
Use the **arrow buttons** to set the day, continue with the **OK button**.  
Use the **arrow buttons** to set the month, continue with the **OK button**.  
Use the **arrow buttons** to set the year, confirm with the **OK button**
- **Current time** (chap. 12.4), format HH:MM:  
Use the **arrow buttons** to set the hours, continue with the **OK button**.  
Use the **arrow buttons** to set the minutes, confirm with the **OK button**

Set the controller to the desired temperature, and CO<sub>2</sub> set points that shall be used to operate the chamber (chap. 7).

Only insert samples into the chamber when it has reached its stable operating state.



If there is no accordance between the actual and set value shown in the display, proper operation of the chamber is not guaranteed.

**Temperature:** Equilibration time is approx. 2 hours.

**CO<sub>2</sub>:** After approx. 5 minutes, the CO<sub>2</sub> concentration equilibrates automatically to the preset value.

**Instructions when observing leakage of condensate from the CO<sub>2</sub> sensor system and CO<sub>2</sub> fluctuation:**

In the case of CO<sub>2</sub> fluctuations and concomitant condensate leakage from the injection and suction nozzle of the CO<sub>2</sub> sensor compartment after start-up or when taking the chamber back into service, the chamber should be left to dry open for at least an hour running at 37 °C with the water pan empty. This will result in flushing the sensor compartment and tubing from humid air. Removing the condensate from the CO<sub>2</sub> sensor system will ensure a turbulence-free CO<sub>2</sub> measurement.

## 6.4 Altitude of the installation site above sea level

After first turning on the incubator, enter the altitude of the site above sea level into the RD4controller. This entry serves to correct the calculation of CO<sub>2</sub> concentration in vol.-% from the measurement of partial pressure. The setting will remain stored after shutting the power off.

Required access level: "Admin".

Path: **Normal display**     **Settings**     **Various**  **Altitude**

Press the **OK button** to enable the setting.

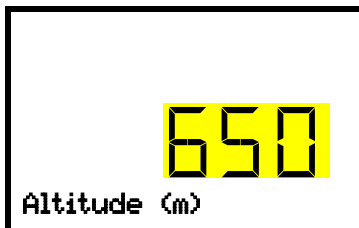

Setting the altitude.

The current setting flashes. Enter the desired altitude. Entry range: 0 m / 0 ft up to 2000 m / 6562 ft.

Confirm the entry with the **OK button**.

With the **Back button** you can go back to the "Various" submenu and, repeatedly pressing it, to **Normal display**.

Unit of altitude above sea level for entry and displayed value: kilometer [km]

Correlation feet [ft] to kilometer [km]: see chap. 27.5.

## 7. Temperature and CO<sub>2</sub> set-point entry

Required access level: "User".

	Setting ranges	Control ranges
Temperature	0 °C / 32 °F up to 50 °C / 122 °F	6 °C / 10.8 °F above ambient up to 50 °C / 122 °F
Humidity	0 vol.-% up to 20 vol.-%	0 vol.-% up to 20 vol.-%

### 7.1 Temperature set-point entry

Path: **Normal display**   **Setpoints**  **Temperature**

Press the **OK button** to enable the setting.

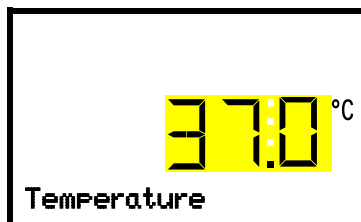

Temperature setting.

The current setting flashes. Enter the desired set-point with the **arrow buttons**.

Confirm the entry with the **OK button**.

With the **arrow-down button** you can continue with the CO<sub>2</sub> set-point entry (chap. 7.2).

With the **Back button** you can go back to the "Setpoints" submenu and, repeatedly pressing it, to **Normal display**.



When setting a lower temperature set point, in order to save time, we recommend cooling down the chamber by turning it off and opening the chamber doors.



With safety controller mode "Limit", adapt the safety controller always when you changed the temperature set-point. Set the safety controller value by approx. 2 °C above the temperature set-point (chap. 11.2).

Recommended setting: safety controller mode "Offset" with safety controller value 2 °C.

### 7.2 CO<sub>2</sub> set-point entry

Path: **Normal display**   **Setpoints**   **CO2**

Press the **OK button** to enable the setting.

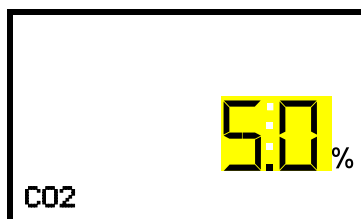

CO<sub>2</sub> set-point setting

The current setting flashes. Enter the desired set-point with the **arrow buttons**.

Confirm the entry with the **OK button**.

With the **arrow-up button** you can go back to the temperature set-point entry (chap. 7.1)

With the **arrow-down button** you can now change to the special controller functions setting (chap. 9)

With the **Back button** you can go back to the "Setpoints" submenu and, repeatedly pressing it, to **Normal display**.





When setting a lower CO<sub>2</sub> set point, the CO<sub>2</sub> gas must be able to escape first. Open the chamber doors for this purpose.



If no CO<sub>2</sub> concentration is indicated (display showing “ – – – –”) the CO<sub>2</sub> sensor is not connected.

### Note when setting high gas concentrations

Carbon dioxide (CO<sub>2</sub>) in high concentrations is hazardous to health. It is colorless and almost odorless and therefore practically imperceptible. Any CO<sub>2</sub> gas that may escape must be safely led out via good room ventilation or a suitable connection to an exhaust system. We recommend installing a CO<sub>2</sub> warning system.

	 <b>WARNING</b>
	<p><b>High concentration of CO<sub>2</sub> (&gt; 4 Vol.-%).</b>  <b>Danger of death by suffocation.</b>  <b>Danger of poisoning.</b></p> <ul style="list-style-type: none"> <li>⊘ Do NOT set up chambers in non-ventilated recesses.</li> <li>➤ Ensure technical ventilation measures.</li> <li>➤ Observe the relevant regulations for handling CO<sub>2</sub>.</li> </ul>

If CO<sub>2</sub> is released, leave the area und inform the security service or fire department.

## 8. Placing samples in the incubator

In order to detect possible transport damages we recommend a 1 or 2 days test run at the desired set-points before placing valuable samples. Then you can load the chamber with the samples.



**WARNING:** If customer should use a chamber running in non-supervised continuous operation, we strongly recommend in case of inclusion of irrecoverable specimen or samples to split such specimen or samples and store them in at least two chambers, if this is feasible.

During the equilibration phase of approx. 2 hours after turning on the chamber, undefined temperature and CO<sub>2</sub> conditions occur within the chamber. During this phase, do not place any sample materials in the chamber

	<b>CAUTION</b>
	<p><b>Danger of samples being destroyed.</b></p> <ul style="list-style-type: none"> <li>➤ Load the incubator only after equilibration of temperature.</li> </ul>

Do not exceed the maximum load of each shelf and the permitted total load (see chap.27.4).

## 9. Setting special controller functions

In the “Functions on/off” menu you can define the switching state of the special controller functions.

Required access level: “User”.

Path: **Normal display**   **Setpoints**    **Functions on/off**

The functions are displayed from left to right.

**Example:** Function 1 “Humidity off” activated = 1000. Function 1 “Humidity off” deactivated = 0000.

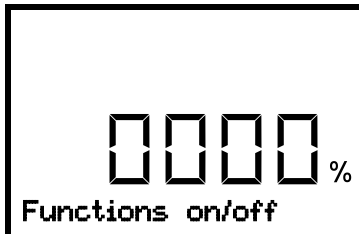

Submenu “**Functions on/off**”.

This view shows the switching states four functions.

“1” = Function activated

“0” = Function deactivated

Press the **OK button** to access the first individual function. With the **arrow-down button** you can proceed to the subsequent functions.

- Function 1 “Idle mode”: Change to “Idle mode”, chap. 9.1
- Function 2 “CO<sub>2</sub> off”: Deactivating CO<sub>2</sub> control, chap. 9.2
- Functions 3 and 4 have no function with this chamber type.

Press the **OK button** to enable the setting of the desired function and select the function’s switching state “1” (function activated) or “0” (function deactivated).

With the **Back button** you can go back to the “**Setpoints**” submenu and, repeatedly pressing it, to **Normal display**.

In Normal display the activated functions are indicated by an icon showing the number of the respective function.

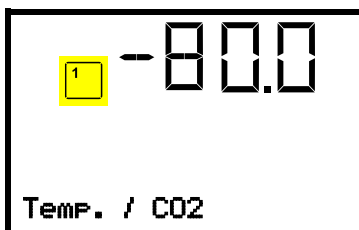

Example:

Normal display with activated function 1 “Idle mode”.

### 9.1 Idle mode

In this operating mode, temperature and CO<sub>2</sub> control are deactivated. The actual values continue to be displayed in Normal Display. This operating mode is switched on or off via the controller function 1 “Idle mode” (chap. 9). In Normal Display the activated function 1 is indicated by an icon showing the number 1.

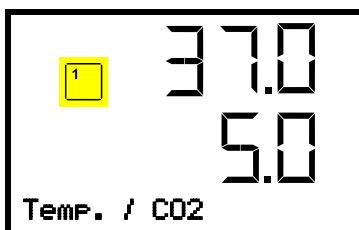

Normal display in “Idle mode” (sample values)

## 9.2 Deactivated CO<sub>2</sub> control

When operating the chamber without a CO<sub>2</sub> gas connection, you can deactivate CO<sub>2</sub> control with the function "CO<sub>2</sub> off" (chap. 9) to avoid alarms of the CO<sub>2</sub> gas system. No CO<sub>2</sub> tolerance range alarms and no pressure alarm will be emitted.

The actual CO<sub>2</sub> value continues to be displayed in Normal Display. The activated function 2 is indicated by an icon showing the number 2.

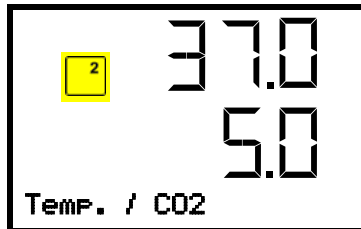

Normal display with deactivated CO<sub>2</sub> control (sample values)

## 10. Password

### 10.1 Password request

To access menus for which access is restricted, you must enter the corresponding password.

After calling the appropriate menu function with the **OK button** the password request appears.

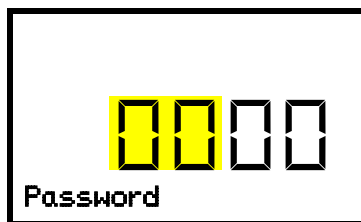

Password request.

The left two digits are flashing. Enter the desired numbers with the **arrow buttons**.

Confirm the setting with the **OK button**.

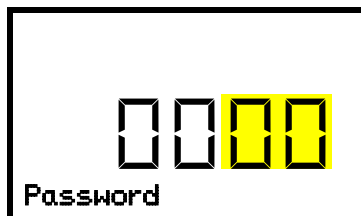

Password request.

The right two digits are flashing. Enter the desired numbers with the **arrow buttons**.

Confirm the setting with the **OK button**.

Upon entering an incorrect password, the information message "Wrong password" is displayed.

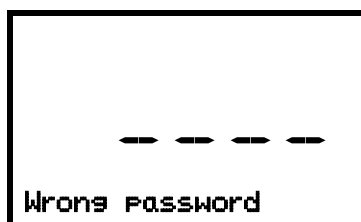

Display "Wrong password".

After 3 seconds the controller changes again to the password entry.

Enter the correct password.

Following correct password entry you can access the desired menu function.



## 10.2 Assign and modify a password

In this menu you can assign and modify the passwords of the “User” and “Admin” access levels.

Required access level: “Admin”.



Keep the password well in mind. There is no access to the corresponding menu functions without the correct password.

### 10.2.1 Assign and modify the User password

Path: **Normal display** ▾ ▾ ▾ ▾ **Settings**  **Chamber** ▾ ▾ ▾ ▾ **Password User**

Press the **OK button** to enable the setting.

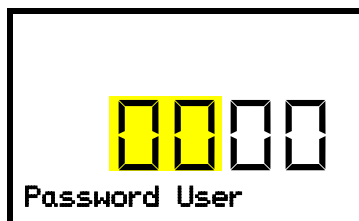

Setting the User password.  
The left two digits are flashing. Enter the desired numbers with the **arrow buttons**.  
Confirm the setting with the **OK button**.

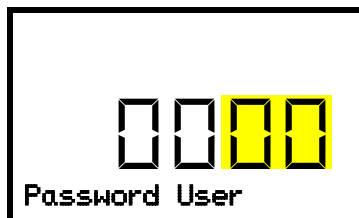

Setting the User password.  
The right two digits are flashing. Enter the desired numbers with the **arrow buttons**.  
Confirm the setting with the **OK button**.

With the **arrow-down button** you can now proceed to enter the Admin password.

With the **Back button** you can go back to the “**Chamber**” submenu and, repeatedly pressing it, to **Normal display**.

### 10.2.2 Assign and modify the Admin password

Path: **Normal display** ▾ ▾ ▾ ▾ **Settings**  **Chamber** ▾ ▾ ▾ ▾ **Password Admin**

Press the **OK button** to enable the setting.

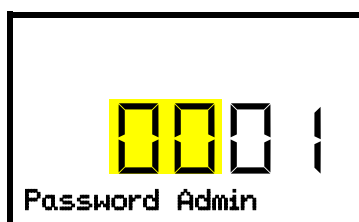

Setting the Admin password.  
The left two digits are flashing. Enter the desired numbers with the **arrow buttons**.  
Confirm the setting with the **OK button**.

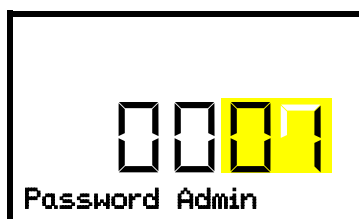

Setting the Admin password.  
The right two digits are flashing. Enter the desired numbers with the **arrow buttons**.  
Confirm the setting with the **OK button**.

With the **Back button** you can go back to the “**Chamber**” submenu and, repeatedly pressing it, to **Normal display**.

## 11. Temperature safety devices

### 11.1 Over temperature protective device (class 1)

The CO<sub>2</sub> incubator is equipped with one (C-UL) or two (C) internal temperature safety devices class 1 acc. to DIN 12880:2007. They serve to protect the chamber and prevent dangerous conditions caused by major defects.

If one of the over temperature protective devices permanently turns off the chamber, the user cannot restart the device again. The protective cut-off devices are located internally. Only a service specialist can replace them. Therefore, please contact an authorized service provider or BINDER Service.

### 11.2 Overtemperature safety controller class 3.1

The chambers are regularly equipped with an electronic overtemperature safety controller (temperature safety device class 3.1 according to DIN 12880:2007). If an error occurs, the safety controller performs a regulatory function.

Please observe the DGUV guidelines 213-850 on safe working in laboratories, issued by the employers' liability insurance association (for Germany).

The overtemperature safety controller serves to protect the chamber, its environment and the contents from exceeding the maximum permissible temperature. In the case of an error, it limits the temperature inside the chamber to the entered safety controller value. This condition (state of alarm) is indicated visually and additionally with an audible alert if the buzzer is enabled (chap. 15.3). The alarm persists until the chamber cools down below the configured safety controller value and the alarm is reset on the controller.

	Check the setting regularly and adjust it following changes of the temperature set-point or charge.
---	---

	The safety controller only activates after the set-point has been reached once.
---	---

You can set the **safety controller mode** to "Limit" or "Offset".

- Limit:** Limit value, absolute maximum permitted temperature value  
 This setting offers high safety as a defined temperature limit will not be exceeded. It is important to adapt the safety controller value after each modification of the temperature set-point. Otherwise, the limit could be too high to ensure efficient protection, or, in the opposite case, it could prevent the controller from reaching an entered set-point outside the limit range.
- Offset:** Offset value, maximum overtemperature above any active temperature set point. The resulting maximum temperature changes internally and automatically with every temperature set-point change.

#### Example:

Desired temperature value: 37 °C, desired safety controller value: 39 °C.

Possible settings for this example:

Temperature set point	Safety controller mode	Safety controller value
37 °C	Limit	Limit value 39 °C
	Offset	Offset value 2 °C

**Factory setting:** Safety controller mode "Offset" with safety controller value 2 °C.

	The settings of the safety controller are inactive during sterilization (chap. 23). They become functional again following abortion of the sterilization and/or the restart of the chamber at the main power switch.
---	--

### 11.2.1 Setting the safety controller mode

Required access level: "User".

Path: **Normal display**   **Setpoints**    **Safety controller**  **Mode**

Press the **OK button** to enable the setting.

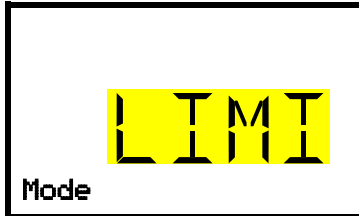

Setting the safety controller mode

The current setting flashes. Use the **arrow buttons** to select between LIMI (Limit) and OFFS (Offset).

Confirm the setting with the **OK button**.

With the **arrow-down button** you proceed to setting the safety controller value (chap. 11.2.2)

With the **Back button** you can go back to the "**Safety controller**" submenu and, repeatedly pressing it, to **Normal display**.

### 11.2.2 Setting the safety controller value

Required access level: "User".

The desired safety controller mode must be selected first (chap. 11.2.1). Depending on the mode setting, one of the following setting menus will appear.

Path: **Normal display**   **Setpoints**    **Safety controller**   **Limit** or **Offset**

Press the **OK button** to enable the setting.

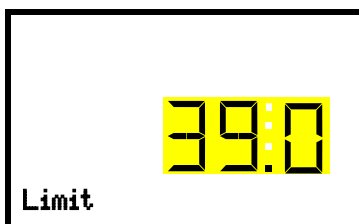

Setting the safety controller value with "Limit" safety controller mode.

The current value flashes. Enter the desired limit value with the **arrow buttons**.

Confirm the entry with the **OK button**.

or

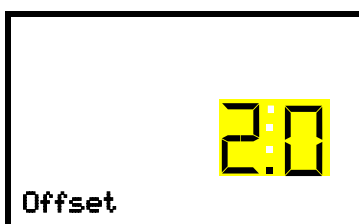

Setting the safety controller value with "Offset" safety controller mode

The current value flashes. Enter the desired offset value with the **arrow buttons**.

Confirm the entry with the **OK button**.

With the **Back button** you can go back to the "**Safety controller**" submenu and, repeatedly pressing it, to **Normal display**.



Regularly check the settings of the safety controller mode and value.

Set the safety controller value by approx. 2 °C above the desired temperature set-point.

### 11.2.3 Message and measures in the state of alarm

The state of alarm is indicated visually in Normal display. If the buzzer is enabled (chap. 15.3) there is an additional audible alert. The heating turns off. As soon as the inner chamber temperature has cooled down below the safety controller value, the heating is released and temperature control continues.

In Normal display a text message indicates the alarm cause. The “collective alarm” icon flashes. If the audible arm is activated, the buzzer sounds. Press the **OK button** to mute the buzzer.

The alarm message “Safety controller” and the “Collective alarm” icon are displayed on the controller until you press the **OK button** on the controller **and** the inner chamber temperature has cooled down below the safety controller value.

- If the inner chamber temperature has already cooled down below the safety controller value when pressing the **OK button**, the alarm message “Safety controller” and the “Collective alarm” icon are reset together with the buzzer.
- If the state of alarm is still active when pressing the **OK button**, i.e. the inner chamber temperature is still above the safety controller value, first only the buzzer is reset. The alarm message “Safety controller” and the “Collective alarm” icon will disappear as soon as the inner chamber temperature falls below the safety controller value.
- The alarm remains active until it is acknowledged on the controller and the inner temperature falls below the entered safety controller setpoint. Then the heating is released again.



Normal display showing safety controller alarm (sample values)

**Note:**

When the safety controller class 3.1 had been activated you should disconnect the chamber from the power supply and have an expert examine and rectify the cause of the fault.

### 11.2.4 Function check

Check the safety controller at appropriate intervals for its functionality. It is recommended that the authorized operating personnel should perform such a check, e.g., before starting a longer work procedure.

## 12. General controller settings

The general settings can be accessed in the “**Settings**” submenu, which is available for users with “Service” or “Admin” authorization level. It serves to enter date and time, select the language for the controller menus and the desired temperature unit and to configure the controller’s communication functions.

The display of some network settings is available for all users in the “**Chamber info**” menu.

### 12.1 Selecting the controller’s menu language

The RD4 controller communicates by a menu guide using real words in German, English, French, Spanish, and Italian languages.

Required access level: “Admin”. Following start-up of the chamber (chap. 6.3), it is “User”.

Path: **Normal display**     **Settings**  **Chamber**    **Language\***

\* Following start-up of the chamber: **Sprache / Language / Langue / Idioma / Lingua**, depending on the language selected before turning off the chamber

Press the **OK button** to enable the setting.

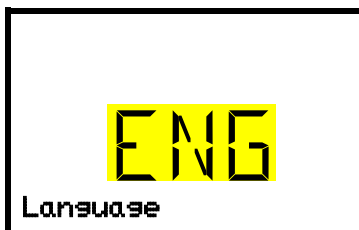

Setting the menu language (example: English).  
The current setting flashes. Use the **arrow buttons** to select the desired language.  
Confirm the entry with the **OK button**.

With the **arrow-down button (twice)** you can now change to the temperature unit setting.

With the **Back button** you can go back to the “**Chamber**” submenu and, repeatedly pressing it, to **Normal display**.

### 12.2 Selecting the temperature unit

Required access level: “Admin”. Following start-up of the chamber (chap. 6.3), it is “User”.

Path: **Normal display**     **Settings**  **Chamber**      **Temperature unit**

Press the **OK button** to enable the setting.

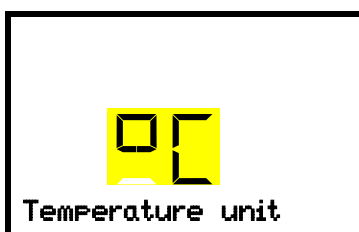

Setting the temperature unit  
The current setting flashes. Use the **arrow buttons** to select between °C (degrees Celsius) and °F (degrees Fahrenheit).  
Confirm the entry with the **OK button**.

You can change the temperature unit between °C and °F.

If the unit is changed, all values are converted accordingly



C = degree Celsius

0 °C = 31°F

Conversion:

F = degree Fahrenheit

100 °C = 212°F

[value in °F] = [value in °C] \* 1,8 + 32

With the **Back button** you can go back to the “**Chamber**” submenu and, repeatedly pressing it, to **Normal display**.

## 12.3 Setting the current date

Required access level: "Admin". Following start-up of the chamber (chap. 6.3), it is "User".

Path: **Normal display**     **Settings**  **Chamber**  **Date**

Press the **OK button** to enable the setting.

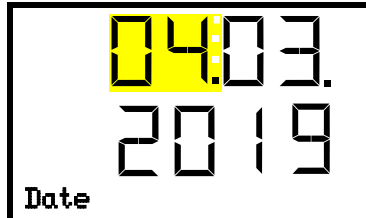

Setting the date: day

The current setting flashes. Enter the current day with the **arrow buttons**.

Confirm the entry with the **OK button**.



Setting the date: month

The current setting flashes. Enter the current month with the **arrow buttons**.

Confirm the entry with the **OK button**.

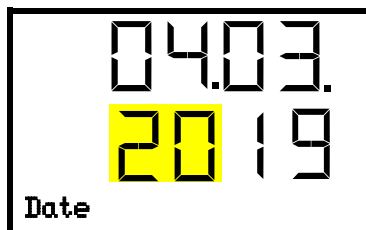

Setting the date: year

The left two digits are flashing. Enter the first two digits of the current year with the **arrow buttons**.

Confirm the entry with the **OK button**.

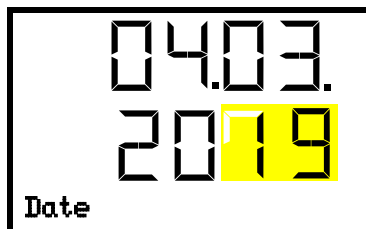

Setting the date: year

The right two digits are flashing. Enter the last two digits of the current year with the **arrow buttons**.

Confirm the entry with the **OK button**.

With the **arrow-down button** you can now change to setting the current time.

With the **Back button** you can go back to the "**Chamber**" submenu and, repeatedly pressing it, to **Normal display**.

## 12.4 Setting the current time

Required access level: "Admin". Following start-up of the chamber (chap. 6.3), it is "User".

Path: **Normal display**     **Settings**  **Chamber**   **Time**

Press the **OK button** to enable the setting.

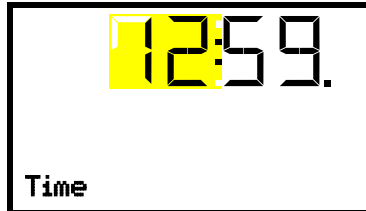

Setting the time: hours  
The current setting flashes. Enter the current hour with the **arrow buttons**.  
Confirm the entry with the **OK button**.

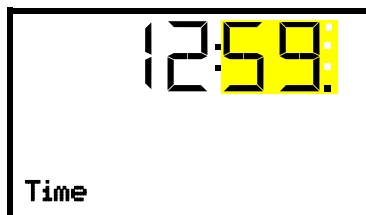

Setting the time: minutes  
The current setting flashes. Enter the current minutes with the **arrow buttons**.  
Confirm the entry with the **OK button**.

With the **Back button** you can go back to the "**Chamber**" submenu and, repeatedly pressing it, to **Normal display**.

## 12.5 Function "Language selection at restart"

If the function "Language selection at restart" is activated, menu language, date, time, and temperature unit are checked with every startup of the chamber. At this occasion it is also possible to modify them with "User" access level.

Required access level: "Admin".

Path: **Normal display**     **Settings**  **Chamber**     **Language selection at restart**

Press the **OK button** to enable the setting.



Function "Language selection at restart"  
The current setting flashes. Use the **arrow buttons** to select between ON and OFF.  
Confirm the setting with the **OK button**.

With the **arrow-down button** you can now change to the next parameter (chamber address).

With the **Back button** you can go back to the "**Chamber**" submenu and, repeatedly pressing it, to **Normal display**.

## 12.6 Setting the chamber address

This setting is required for the communication with the BINDER APT-COM™ 4 Multi Management Software. The chamber address settings in the chamber controller and in the software must be identical.

Required access level: "Admin".

Path: **Normal display**     **Settings**  **Chamber**       **Chamber address**

Press the **OK button** to enable the setting.



Setting the chamber address

The current setting flashes. Enter the desired address with the **arrow buttons**. Setting range: 1 up to 254

Confirm the entry with the **OK button**.

With the **arrow-down button** you can now change to the next parameter (display brightness).

With the **Back button** you can go back to the "**Chamber**" submenu and, repeatedly pressing it, to **Normal display**.

## 12.7 Display brightness

Required access level: "Admin".

Path: **Normal display**     **Settings**  **Chamber**       **Brightness**

Press the **OK button** to enable the setting.



Setting the display brightness

The current setting flashes. Enter the desired value with the **arrow buttons**. Setting range: 10% up to 100%

Confirm the entry with the **OK button**.

With the **arrow-down button** you can now change to the next parameter (audible alarm, chap. 15.3).

With the **Back button** you can go back to the "**Chamber**" submenu and, repeatedly pressing it, to **Normal display**.



## 13. Tolerance range settings

In this menu you can define for temperature and CO<sub>2</sub> the deviation between the actual value and setpoint, which shall cause a tolerance range alarm. The entered value defines the limit of permitted deviations from the set-point (exceeding and falling below). Reaching this limit triggers tolerance alarm.

In addition you can specify a delay time for this alarm.

If there are any actual values outside the tolerance range, after the configured alarm delay time the alarm message "Temperature range" and / or "CO<sub>2</sub> range" is displayed in Normal display (chap. 15.1). If the alarm buzzer is activated (chap. 15.3) there is an audible alert.

This function only activates after the set-point has been reached once.

Required access level: "Admin".

### 13.1 Setting the delay time for tolerance range alarm

Path: **Normal display** ▾ ▾ ▾ ▾ **Settings**  ▾ ▾ ▾ **Various**  ▾ ▾ **Range alarm delay (min)**

Press the **OK button** to enable the setting.

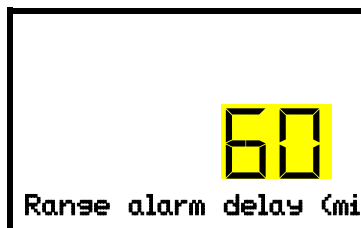

Setting the tolerance range alarm delay.

The current setting flashes. Use the **arrow buttons** to enter the desired time after which the range alarm shall be triggered. Entry range: 1 up to 120 minutes.

Confirm the entry with the **OK button**.

With the **arrow-down button** you can now change to the temperature tolerance range setting.

With the **Back button** you can go back to the "**Various**" submenu and, repeatedly pressing it, to **Normal display**.

### 13.2 Setting the temperature tolerance range

Path: **Normal display** ▾ ▾ ▾ ▾ **Settings**  ▾ ▾ ▾ **Various**  ▾ ▾ **Temperature range**

Press the **OK button** to enable the setting.

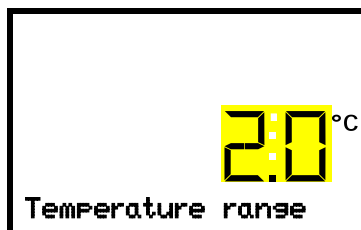

Setting the temperature tolerance range

The current setting flashes. Enter the desired temperature range with the **arrow buttons**. Entry range: 1.0 °C up to 10.0 °C

Confirm the entry with the **OK button**.

With the **arrow-up button** you can go back to the tolerance range alarm delay setting.

With the **arrow-down button** you can now change to the CO<sub>2</sub> tolerance range setting.

With the **Back button** you can go back to the "**Various**" submenu and, repeatedly pressing it, to **Normal display**.

### 13.3 Setting the CO<sub>2</sub> tolerance range

Path: **Normal display** ▾ ▾ ▾ ▾ **Settings**  ▾ ▾ ▾ **Various**  ▾ ▾ ▾ **CO<sub>2</sub> range**

Press the **OK button** to enable the setting.

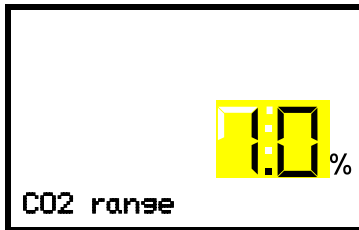

Setting the CO<sub>2</sub> tolerance range

The current setting flashes. Enter the desired CO<sub>2</sub> range with the **arrow buttons**. Entry range: 1.0 vol.-% up to 10.0 vol.-%

Confirm the entry with the **OK button**.

With the **arrow-up button** you can go back to the temperature range setting

With the **arrow-down button** you can now change to the door open alarm delay setting.

With the **Back button** you can go back to the “**Various**” submenu and, repeatedly pressing it, to **Normal display**.

### 13.4 Setting the delay time for door open alarm

Path: **Normal display** ▾ ▾ ▾ ▾ **Settings**  ▾ ▾ ▾ **Various**  ▾ ▾ ▾ **Door alarm delay (min)**

Press the **OK button** to enable the setting.

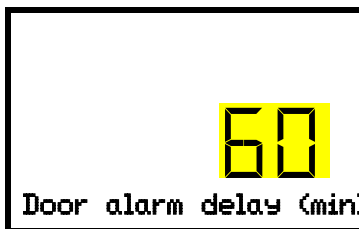

Setting the door open alarm delay.

The current setting flashes. Use the **arrow buttons** to enter the desired time after which the door alarm shall be triggered. Entry range: 1 up to 120 minutes.

Confirm the entry with the **OK button**.

With the **arrow-up button** you can go back to the CO<sub>2</sub> tolerance range setting

With the **arrow-down button** you can now change to the humidity control setting.

With the **Back button** you can go back to the “**Various**” submenu and, repeatedly pressing it, to **Normal display**.

## 14. Chamber settings (for experienced users only)

### 14.1 Setting the humidity control

The humidifying system provides a maximum humidity of up to 95 % r.h. in the inner chamber, which remains condensation-free. This performance assumes an average ambient temperature of +22 °C +/- 3 °C / 71.6 °F +/- 5.4 °F and a working temperature in the inner chamber of 37 °C / 98.6 °F.

Depending on the installation site and ambient temperature you can increase or decrease the humidity by up to +/- 5 % r.h. if required. Factory setting: 0 % r.h.

	If the ambient temperature deviates by more than +/- 5 °C from the values recommended by the manufacturer, the conditions for maximum air humidity with condensation-free inner chamber are no longer guaranteed. Contact BINDER Service for assistance.
---	--

Path: **Normal display** ▾ ▾ ▾ ▾ **Settings**  ▾ ▾ ▾ **Various**  ▾ ▾ ▾ ▾ ▾ **Humidity control**

Press the **OK button** to enable the setting.



Setting the humidity control  
The current setting flashes. Enter the desired value with the **arrow buttons**. Entry range: -5 % r.h. up to +5 % r.h.  
Confirm the entry with the **OK button**.

With the **arrow-up button** you can change to the door open alarm delay setting (chap. 13.4).

With the **arrow-down button** you can now change to the door heating offset setting.

With the **Back button** you can go back to the “**Various**” submenu and, repeatedly pressing it, to **Normal display**.

### 14.2 Setting the door heating offset

In unfavorable ambient conditions, condensation may occur in the door area. To avoid this, an Offset value for the door heating can be set. Factory setting: 3.0 °C.

	If the ambient temperature deviates by more than +/- 5 °C from the values recommended by the manufacturer, the conditions for maximum air humidity with condensation-free inner chamber are no longer guaranteed. Contact BINDER Service for assistance.
---	--

Path: **Normal display** ▾ ▾ ▾ ▾ **Settings**  ▾ ▾ ▾ **Various**  ▾ ▾ ▾ ▾ ▾ **Doortemp. offset**

Press the **OK button** to enable the setting.



Setting the door temperature offset.  
The current setting flashes. Enter the desired value with the **arrow buttons**. Entry range: -5.0 °C up to +5.0 °C.  
Confirm the entry with the **OK button**.

With the **arrow-up button** you can go back to the humidity control setting.

With the **Back button** you can go back to the “**Various**” submenu and, repeatedly pressing it, to **Normal display**.

### 14.3 Adjusting the heating power – for BINDER Service only

Depending on the duration of the door opening, a heating power factor for humidity recovery time can be adapted. Factory setting: 12.0.

	This setting is intended for BINDER Service only!
---	---

Path: **Normal display**     **Settings**     **Various**          **Factor humid. recovery**

Press the **OK button** to enable the setting.



Setting the heating power factor for humidity recovery time.  
The current setting flashes. Enter the desired factor with the **arrow buttons**. Entry range: 0.0 to 100.0.  
Confirm the entry with the **OK button**.

With the **arrow-up button** you can go back to the door heating offset setting.

With the **Back button** you can go back to the “**Various**” submenu and, repeatedly pressing it, to **Normal display**.

## 15. Notification and alarm functions

### 15.1 Alarm messages



**WARNING:** If customer should use a chamber running in non-supervised continuous operation, we strongly recommend in case of inclusion of irrecoverable specimen or samples to split such specimen or samples and store them in at least two chambers, if this is feasible.

In the event of equipment failures, or when the temperature and / or CO<sub>2</sub> deviate from the set tolerance range limits, optical and possibly acoustic alarm messages are given out via the controller. A zero-voltage relay alarm output (9) (chap. 15.5) permits transmission of the alarm e.g., to a central monitoring system.

The alarm messages door open and leaving the tolerance range are emitted after a configurable delay (chap. 13), the others immediately when the fault occurs. The tolerance range alarms are suppressed after opening the chamber door or turning on the chamber until the corresponding setpoint is reached, and then for the selected delay time.



In Normal display a text message indicates the alarm cause. The “collective alarm” icon flashes. If the audible arm is activated, the buzzer sounds.

If more than one alarm signal is sent simultaneously, they are displayed in a cycle.

Press the **OK button** to confirm the alarm and mute the buzzer. If the alarm cause is still valid, the “collective alarm” icon is lit.



Alarm indication (example: safety controller alarm)

#### Alarm messages overview:

Condition	Icon	Alarm message	Moment of alarm message and switching the zero-voltage alarm relay output
Chamber door open		“Door open”	after configurable time (chap. 13.4). Factory setting: 1 minute
Setpoint of the safety controller class 3.1 exceeded		“Safety controller”	immediately
Tolerance range alarm: actual temperature value exceeding the tolerance range)		“Temperature range”	after configurable time (chap. 13.1) Factory setting: 10 minutes
Tolerance range alarm: actual CO <sub>2</sub> value exceeding the tolerance range		“CO <sub>2</sub> range”	after configurable time (chap. 13.1) Factory setting: 10 minutes
CO <sub>2</sub> pressure too low		“CO <sub>2</sub> pressure”	immediately
Inner temperature sensor defective. Control continues using the safety controller temperature sensor.		Actual temperature value display shows “ - - - - ”	immediately
		“Inner temp. sensor”	

Condition	Icon	Alarm message	Moment of alarm message and switching the zero-voltage alarm relay output
Failure of safety controller temperature sensor		Messages alternating: "Safety controller" and "Safety control sensor"	immediately
Failure of inner temperature sensor <u>and</u> safety controller temperature sensor		Actual temperature value display shows " _ _ _ _ "	immediately
		Messages alternating: "Inner temp. sensor", "Safety controller", and "Safety control sensor"	
Failure of temperature sensor for door heating		"Door heating sensor"	immediately
Failure of CO <sub>2</sub> sensor		Actual CO <sub>2</sub> value display shows " _ _ _ _ "	immediately
		"CO <sub>2</sub> sensor defective"	after 1 minute
CO <sub>2</sub> sensor not connected		Actual CO <sub>2</sub> value display shows " _ _ _ _ "	immediately
Sterilization terminated prematurely after less than 6 hours: Ineffective sterilization		"Sterilization failed"	immediately

Press the **OK button** to confirm the alarm.

- Confirmation while the state of alarm persists: Only the buzzer is muted. The visual alarm message continues to be displayed until the alarm condition is removed. Then it is reset automatically.
- Confirmation after the alarm has ended: The buzzer and the visual alarm message are reset together.



When operating the chamber without CO<sub>2</sub> gas connection, turn off CO<sub>2</sub> control (function "CO<sub>2</sub> off", chap. 9) in order to avoid alarms of the CO<sub>2</sub> gas system.

## 15.2 Information messages

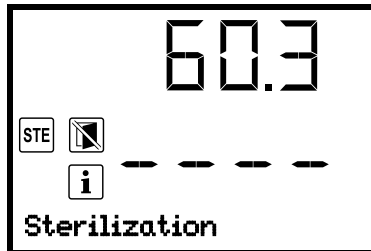

Information messages provide information about the settings made or the current controller condition.

 In Normal display a text message indicates the condition. The “Information” icon is lit.



Information message (example: sterilization running)

### Information messages overview:

Condition	Icon	Information message	Moment of information message
Trying to start sterilization cycle while the CO <sub>2</sub> sensor still plugged-in		“CO2 sensor plugged-in”	Sterilization start
Sterilization is running	 	“Sterilization”	During sterilization
Sterilization successfully completed		“Sterilization success”	After 6 hours of sterilization cycle
Recommended maintenance interval (one year of operation) is over.		“Service due!”	Each week of operation after maintenance interval is over.

Press the **OK button** to confirm the information message.

## 15.3 Activating / deactivating the audible alarm (alarm buzzer)

Path: **Normal display**     **Settings**  **Chamber**         **Audible alarm**

Press the **OK button** to enable the setting.



Setting the audible alarm.

The current setting flashes. Use the **arrow buttons** to select between ON and OFF.

Confirm the setting with the **OK button**.

With the **Back button** you can go back to the “**Chamber**” submenu and, repeatedly pressing it, to **Normal display**.

## 15.4 Measures in case of alarm



Only qualified service personnel authorized by BINDER must perform repair.  
Repaired chambers must comply with the BINDER quality standards.

### 15.4.1 Door open alarm

The open and closed position of the chamber door is controlled via the door contact switch. If the door is open, the temperature and CO<sub>2</sub> controls turn off.

When the door is opened the alarm occurs after an adjustable delay time (chap. 13.4). Factory setting: 1 minute.

- Alarm message “Door open”, “collective alarm” icon
- Audible alarm: buzzer
- Switching the zero-voltage relay alarm output

#### Actions:

- Close the outer door.
- Use the **OK button** to turn off the buzzer even when the door is open.
- The alarm message is cancelled.
- The zero-voltage relay alarm output switches off.

### 15.4.2 Safety controller temperature alarm

The set temperature value (set point type “Limit” or “Offset”) was exceeded.

- Immediate alarm
- Alarm message “Safety controller”, “collective alarm” icon
- Audible alarm: buzzer
- Switching the zero-voltage relay alarm output.

#### Actions:

- Check whether the outer door was open for a long time or is not closed properly. Close the door if necessary. With open door there can be additional door open alarm.
- Check the setting of the safety controller (chap. 11.2). The limit temperature should be at least 2 °C above the temperature set point; the offset temperature should be  $\geq 2$  °C. If necessary, adjust the relevant value.
- Check whether samples were inserted into the chamber that produce heat.
- Check the ambient conditions. The ambient temperature must be at least by 6 °C / 10.8 °F below the temperature set point of the chamber. Protect the chamber from direct sunlight. Ensure sufficient ventilation around the installation location to prevent any buildup of heat in the chamber.
- Check whether the sterilization cycle was terminated prematurely and the chamber has not yet cooled down.
- If these points do not reveal the source of the fault, it may be that the chamber is faulty. Please contact BINDER Service.



### 15.4.3 Temperature tolerance range alarm (overtemperature / too low temperature)



The tolerance range alarm becomes valid only after the setpoint has been reached.

When the actual value leaves the tolerance range the alarm occurs after an adjustable delay time (chap. 13.1). Factory setting: 10 minutes.

- Alarm message “Temperature range”, “collective alarm” icon
- Audible alarm: buzzer
- Switching the zero-voltage relay alarm output

#### Actions:

- Factory setting for the temperature tolerance range is +/- 1.0 K. Modify the value if necessary (chap. 13.2).
- Use the displayed actual temperature value to verify in whether the tolerance range has been exceeded (too warm) or fallen below (too cold).

#### Low temperature alarm:

- Check whether the outer door was open for a long time or is not closed properly. Close the door if necessary. With open door there can be additional door open alarm.
- Check the door's seals for any damage. Replace any damaged seals.

#### Overtemperature alarm:

- Check whether samples were inserted into the chamber that produce heat. Reset the alarm with the **OK button**.
- Check the ambient conditions. The ambient temperature must be at least by 6 °C / 10.8 °F below the temperature set point of the chamber. Protect the chamber from direct sunlight. Ensure sufficient ventilation around the installation location to prevent any buildup of heat in the chamber.
- If these points do not reveal the source of the fault, it may be that the chamber is faulty. Please contact BINDER Service.
- To decrease the temperature, proceed as follows: Turn off the chamber. Open both chamber doors for approx. 5 minutes. Turn on the chamber again. You can restart normal operation as soon as the requested values have equilibrated.



If the same alarm recurs, please contact BINDER Service.

#### 15.4.4 CO<sub>2</sub> tolerance range alarm (CO<sub>2</sub> over/under concentration)

	If CO <sub>2</sub> control has been deactivated (chap. 9.2), no alarms of the CO <sub>2</sub> gas system will be emitted.
---	---

	The tolerance range alarm becomes valid only after the setpoint has been reached.
---	---

When the actual value leaves the tolerance range the alarm occurs after an adjustable delay time (chap. 13.1). Factory setting: 10 minutes.

- Alarm message “CO<sub>2</sub> range”, “collective alarm” icon
- Audible alarm: buzzer
- Switching the zero-voltage relay alarm output

##### **Actions:**

- Factory setting for the CO<sub>2</sub> tolerance range is +/- 1.0 vol.-%. Modify the value if necessary (chap. 13.3)
- Use the displayed actual CO<sub>2</sub> value to verify in whether the tolerance range has been exceeded or fallen below.

##### **CO<sub>2</sub> under concentration alarm:**

- Check whether the outer door was open for a long time or is not closed properly. Close the door if necessary. With open door there can be additional door open alarm.
- Check the door's seals for any damage. Replace any damaged seals.
- If these points do not reveal the source of the fault, it may be that the chamber is faulty. Please contact BINDER Service.

##### **CO<sub>2</sub> over concentration alarm:**

- Open both chamber doors for approx. 30 seconds. Respect the precautions when working with CO<sub>2</sub> gas (chap. 1.6).
- Normal operation can be restarted, as soon as the requested values have been readjusted.
- Reset the alarm message.

	If the same alarm recurs, please contact BINDER Service.
---	--

### 15.4.5 CO<sub>2</sub> pressure alarm



If CO<sub>2</sub> control has been deactivated (chap. 9.2), no alarms of the CO<sub>2</sub> gas system will be emitted.

The CO<sub>2</sub> primary pressure at the intake valve is less than 0.3 bar / 4.4 *psi* below the ambient air pressure.

The alarm displays show a pressure drop of CO<sub>2</sub> admission below 0.3 bar / 4.4 *psi*. Check whether the gas cylinder is open. CO<sub>2</sub> connection pressure is too low.

The alarm occurs immediately.

- Alarm message “CO2 pressure”, “collective alarm” icon.
- Audible alarm: buzzer
- Switching the zero-voltage relay alarm output

#### Actions:

- Check that you have set the pressure on the pressure reducer at 2.0 bar / 29 *psi* above the ambient air pressure, and that all the valves are open for the gas supply.
- Where the CO<sub>2</sub> supply is a pressurized gas cylinder, check that the cylinder still contains sufficient CO<sub>2</sub>. If necessary, replace the gas cylinder. Observe the precautions when handling gases and the correct outlet pressure (chap. 4.4).
- When using central CO<sub>2</sub> supply, check whether the primary pressure is high enough.
- Check that the gas tube has no damage, kinks, blockages or soiling.
- Check when the gas filter was last replaced. Replace the gas filter every year to avoid it blocking. A qualified service engineer should replace the gas filter.
- If these points do not reveal the source of the fault, it may be that the chamber is faulty. Please contact BINDER Service.

The outlet pressure of the gas cylinder must be 2.0 bar / 29 *psi* above the ambient pressure.



#### CAUTION

**Excessive outlet pressure > 2.5 bar / 36 *psi*.**  
**Damage to the chamber.**

- ⊘ The outlet pressure must NOT exceed the indicated value of 2.5 bar / 36 *psi*.
- Before connecting, check the outlet pressure on the pressure reducer of the cylinder.
- Adjust the cylinder outlet pressure to 2.0 bar / 29 *psi* above the ambient pressure.

The recovery times of the gas concentrations inside the chamber following the door being opened, which are indicated in the technical data (chap. 27.4), refer to a connection pressure of 2.0 bar / 29 *psi*. Decreasing supply pressure down to the alarm point of 0.3 bar / 4.4 *psi* results in longer recovery times. Check the pressure displays of your gas supply. If very short recovery times are required or the door is opened frequently, replace the gas cylinders promptly when the pressure decreases below 2.0 bar / 29 *psi*.

### 15.4.6 Power failure alarm

- No alarm message (display is off)
- Audible alarm (buzzer): immediately
- Switching the zero-voltage relay alarm output.



**WARNING:** If customer should use a chamber running in non-supervised continuous operation, we strongly recommend in case of inclusion of irrecoverable specimen or samples to split such specimen or samples and store them in at least two chambers, if this is feasible.

### 15.4.7 Alarms referring to temperature sensor failures

The alarms occur immediately.

- Alarm messages corresponding to the individual alarm cause, “collective alarm” icon
- Audible alarm: buzzer (intermittent sound)
- Switching the zero-voltage relay alarm output
- A sensor fault alarm display takes priority over all other operational displays and alarm signals on the controller.

#### **Actions:**

- Turn off the chamber.
- If necessary, clean and disinfect the chamber. Automatic sterilization is not possible with this fault.
- Please contact BINDER Service.

#### **Failure of inner temperature sensor**

- Actual temperature value display shows “ – – – – ”
- Alarm message “Inner temp. sensor”

Temperature control continues using the safety controller temperature sensor.

#### **Failure of safety controller temperature sensor**

- Alarm messages “Safety controller” and “Safety control sensor” alternating, “collective alarm” icon
- All heating elements turn off.

#### **Failure of inner temperature sensor *and* safety controller temperature sensor**

- Actual temperature value display shows “ – – – – ”
- Alarm messages “Inner temp. sensor”, “Safety controller”, and “Safety control sensor” alternating “collective alarm” icon

All heating elements turn off.

#### **Failure of temperature sensor for door heating**

- Alarm message “Door heating sensor”, “collective alarm” icon

The door heating turns off.

### 15.4.8 Alarms referring to CO<sub>2</sub> sensor failure



If CO<sub>2</sub> control has been deactivated (chap. 9.2), no alarms of the CO<sub>2</sub> gas system will be emitted.

The alarms occur immediately.

#### **Failure of CO<sub>2</sub> sensor**

- Actual CO<sub>2</sub> value display shows “ – – – – ”
- Alarm message “CO<sub>2</sub> sensor defective”, “collective alarm” icon

#### **Actions:**

- Turn off the chamber.
- Remove the sensor (chap. 4.2), replace it if necessary.
- If necessary, clean, disinfect and sterilize the chamber before restarting it
- Please contact BINDER Service.

#### **CO<sub>2</sub> sensor not connected**

- Actual CO<sub>2</sub> value display shows “ – – – – ”

#### **Actions:**

- Turn off the chamber.
- Connect the sensor (chap. 4.2.1)

### 15.4.9 Alarm on ineffective sterilization

The sterilization cycle was terminated prematurely after less than 6 hours (chap. 23.4.1)

- Alarm message “Sterilization failed”, “collective alarm” icon

#### **Actions:**

- Repeat the sterilization, if necessary (chap. 23.3).

## 15.5 Zero-voltage relay alarm output

### Collective alarm output via the zero-voltage relay alarm contact

The chamber is equipped at the rear with a zero-voltage relay output (13) for temperature and CO<sub>2</sub>, which permits the transmission of alarms to an external monitoring system in order to monitor and record the alarm signals. A DIN socket (13) serves to establish this connection.

The zero-voltage relay alarm output switches for all alarm instances and in case of a power failure.

Depending on the alarm cause, the state of alarm is triggered immediately or after an adjustable time (chap. 15.1). With the state of alarm, the “collective alarm” icon flashes on the controller display, a text message indicates the alarm cause, and the buzzer sounds if the acoustic alarm has been activated. The zero-voltage relay alarm contact switches without any delay.

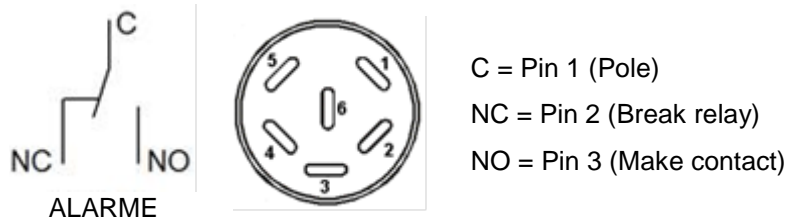



Figure 17: Zero-voltage contacts circuit diagram and pin allocation of DIN socket (13)

In case of no alarm, contact 1 (C) closes with contact 3 (NO).

Closing contact 1 (C) with contact 2 (NC) switches the zero-voltage relay alarm output

**Maximum loading capacity of the switching contacts: 24V AC/DC – 2.5 Amp.**

	 <b>DANGER</b>
	<p><b>Electrical hazard.</b>  <b>Danger of death.</b>  <b>Damage to switching contacts and connection socket.</b></p> <ul style="list-style-type: none"> <li>⊘ Do NOT exceed the maximum switching load of 24V AC/DC – 2.5 Amp.</li> <li>⊘ Do NOT connect any devices with a higher loading capacity.</li> </ul>

The alarm message on the controller display remains displayed during transmission of an alarm via the zero-voltage relay alarm output. As soon as the cause of the alarm is rectified, or the alarm message has been reset, the alarm transmission via the zero-voltage relay outputs is reset together with the alarm message on the controller display.

In case of power failure, transmission of the alarm via zero-voltage relay outputs remains active for the duration of the power failure. When power supply returns, contact 1 (C) closes automatically with contact 3 (NO).

### Connection to an external monitoring system

To ensure short-circuit-proof alarm monitoring that will trigger the alarm when the chamber connection to an external alarm monitor is interrupted, connect the external alarm monitoring system to the chamber via the contacts 1 (C) and 3 (NO). In this case, power failure will also trigger the alarm.

## 16. Ethernet network settings

The settings of the “**Ethernet**” submenu are used for networking chambers with an Ethernet interface, e.g. to connect them with BINDER’s APT-COM™ 4 Multi Management Software (option, chap. 20.4).

### 16.1 Showing the network settings

Required access level: “User”.

The “**Ethernet**” submenu offers to subsequently or individually access the following information:

- MAC address
- IP address
- Subnet mask
- Standard gateway
- DNS server address
- DNS chamber name

#### 16.1.1 Showing the chamber’s MAC address

Path: **Normal display** ▾ ▾ ▾ **Chamber info**      **Ethernet**  **MAC address**

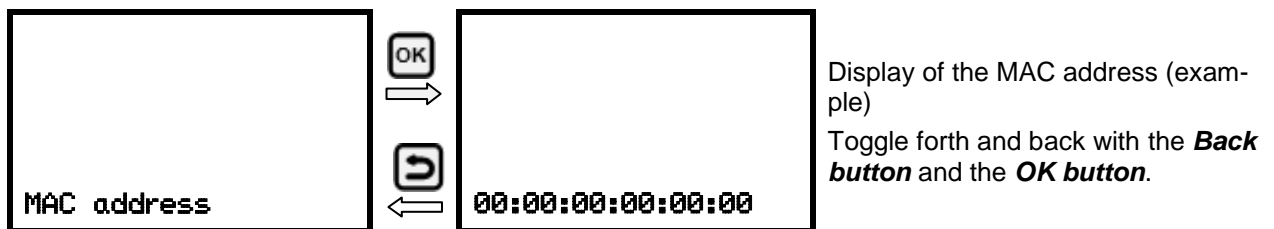

With the **arrow-down button** you can now change to the next parameter (IP address).

With the **Back button** you can go back to the “**Ethernet**” submenu and, repeatedly pressing it, to **Normal display**.

#### 16.1.2 Showing the IP address

Path: **Normal display** ▾ ▾ ▾ **Chamber info**       **Ethernet**   **IP address**



With the **arrow-down button** you can now change to the next parameter (subnet mask).

With the **Back button** you can go back to the “**Ethernet**” submenu and, repeatedly pressing it, to **Normal display**.

### 16.1.3 Showing the subnet mask

Path: **Normal display** ▾ ▾ ▾ **Chamber info**  ▾ ▾ ▾ ▾ **Ethernet**  ▾ ▾ **Subnet mask**

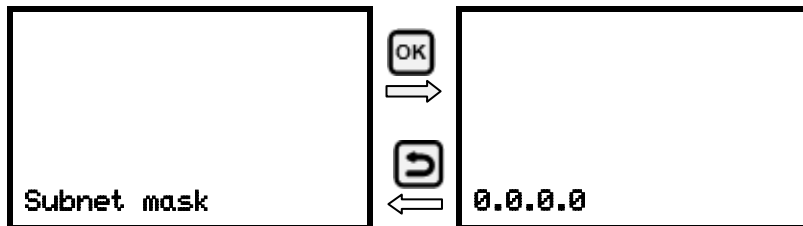

Display of the subnet mask (example)  
Toggle forth and back with the **Back button** and the **OK button**.

With the **arrow-down button** you can now change to the next parameter (standard gateway).

With the **Back button** you can go back to the “**Ethernet**” submenu and, repeatedly pressing it, to **Normal display**.

### 16.1.4 Showing the standard gateway

Path: **Normal display** ▾ ▾ ▾ **Chamber info**  ▾ ▾ ▾ ▾ **Ethernet**  ▾ ▾ ▾ **Standard gateway**

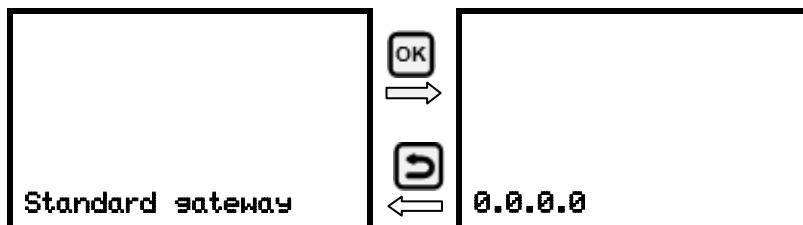

Display of the standard gateway (example)  
Toggle forth and back with the **Back button** and the **OK button**.

With the **arrow-down button** you can now change to the next parameter (DNS server address).

With the **Back button** you can go back to the “**Ethernet**” submenu and, repeatedly pressing it, to **Normal display**.

### 16.1.5 Showing the DNS server address

Path: **Normal display** ▾ ▾ ▾ **Chamber info**  ▾ ▾ ▾ ▾ **Ethernet**  ▾ ▾ ▾ ▾ **DNS server address**

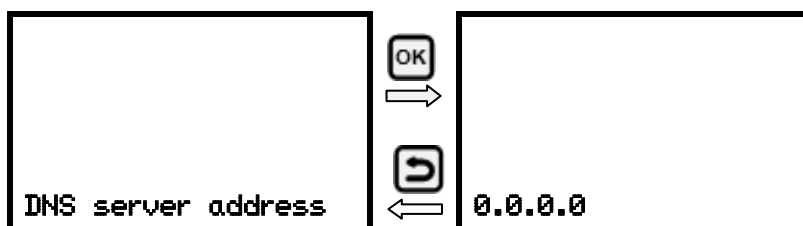

Display of the DNS server address (example)  
Toggle forth and back with the **Back button** and the **OK button**.

With the **arrow-down button** you can now change to the next parameter (DNS chamber name).

With the **Back button** you can go back to the “**Ethernet**” submenu and, repeatedly pressing it, to **Normal display**.



### 16.1.6 Showing the DNS chamber name

Path: **Normal display** ▾ ▾ ▾ **Chamber info**  ▾ ▾ ▾ ▾ **Ethernet**  ▾ ▾ ▾ ▾ **DNS chamber name**

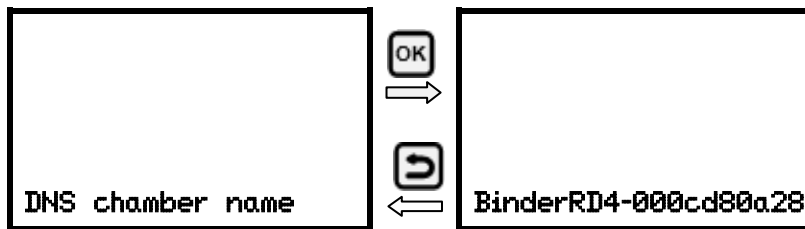

Display of the DNS chamber name (example)  
Toggle forth and back with the **Back button** and the **OK button**.

With the **Back button** you can go back to the “**Ethernet**” submenu and, repeatedly pressing it, to **Normal display**.

## 16.2 Changing the configuration of the network settings

Required access level: “Admin”.

The “**Ethernet**” submenu offers to subsequently or individually access the following settings:

- Selecting the type of assignment (automatic or manual) of the IP address, chap. 16.2.1

If automatic IP address assignment has been selected:

- Selecting the type of assignment (automatic or manual) of the DNS server address, chap. 16.2.2

If manual IP address assignment has been selected:

- Assigning the IP address, chap. 16.2.3
- Assigning the subnet mask, chap. 16.2.4
- Assigning the standard gateway, chap. 16.2.5

If manual IP address assignment or manual DNS server address assignment has been selected:

- Assigning the DNS server address, chap. 16.2.6

### 16.2.1 Selecting the type of IP address assignment (automatic / manual)

Path: **Normal display** ▾ ▾ ▾ ▾ **Settings**  ▾ **Ethernet**  **IP address assignment**

Press the **OK button** to enable the setting



Selection of the type of assignment of the IP address.

The current setting flashes. Use the **arrow buttons** to select between AUTO (automatic) and MANU (manual).

Confirm the setting with the **OK button**.

With the **arrow-down button** you can now change to the next parameter.

- If manual IP address assignment has been selected: assign the IP address (chap. 16.2.3)
- If automatic IP address assignment has been selected: select the type of assignment of the DNS server address (chap. 16.2.2).

With the **Back button** you can go back to the “**Ethernet**” submenu and, repeatedly pressing it, to **Normal display**.

## 16.2.2 Selecting the type of assignment of the DNS server address (automatic / manual)

Access to this function is possible only if automatic IP address assignment has been selected (chap. 16.2.1).

Path: **Normal display**     **Settings**   **Ethernet**    **DNS server**

Press the **OK button** to enable the setting.

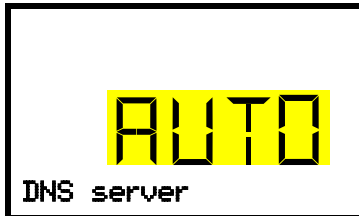

Selection of the type of assignment of the DNS server address.

The current setting flashes. Use the **arrow buttons** to select between AUTO (automatic) and MANU (manual).

Confirm the setting with the **OK button**.

If manual assignment of the DNS server address has been selected, you can now change with the **arrow-down button** to assign the DNS server address (chap. 16.2.6).

With the **Back button** you can go back to the "Ethernet" submenu and, repeatedly pressing it, to **Normal display**.

## 16.2.3 Assigning the IP address

Access to this function is possible only if manual IP address assignment has been selected (chap. 16.2.1)

Path: **Normal display**     **Settings**   **Ethernet**    **IP address**

Press the **OK button** to enable the setting.

The IP address entry is done in four steps, corresponding to the number sections: (1).(2).(3).(4)

Principle of entry:

- Use the **OK button** to select the desired section of the IP address 1/4, 2/4, 3/4, 4/4 in the upper display line
- Use the **Arrow buttons** to enter the value for the selected section of the IP address



IP address assignment (sample values).

The first section of the IP address is shown. Enter the desired value with the **arrow buttons**.

Use the **OK button** to confirm the entry and proceed to the second section of the IP address.

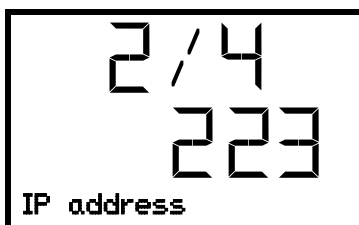

IP address assignment (sample values).

The second section of the IP address is shown. Enter the desired value with the **arrow buttons**.

Use the **OK button** to confirm the entry and proceed to the third section of the IP address.

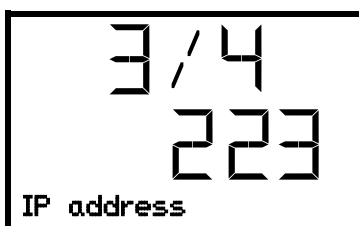

IP address assignment (sample values).

The third section of the IP address is shown. Enter the desired value with the **arrow buttons**.

Use the **OK button** to confirm the entry and proceed to the last section of the IP address.

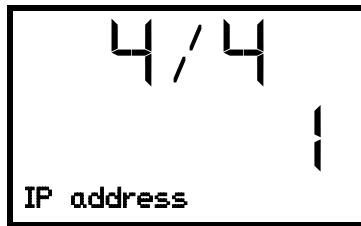

IP address assignment (sample values).

The forth section of the IP address is shown. Enter the desired value with the **arrow buttons**.

Confirm the setting with the **OK button**.

With the **arrow-down button** you can now change to the enter the subnet mask.

With the **Back button** you can go back to the “Ethernet” submenu and, repeatedly pressing it, to **Normal display**.

#### 16.2.4 Setting the subnet mask

Access to this function is possible only if manual IP address assignment has been selected (chap. 16.2.1)

Path: **Normal display**     **Settings**   **Ethernet**     **Subnet mask**

Press the **OK button** to enable the setting.

The subnet mask entry is done in four steps, corresponding to the number sections: (1).(2).(3).(4)

Principle of entry:

- Use the **OK button** to select the desired section of the subnet mask 1/4, 2/4, 3/4, 4/4 in the upper display line
- Use the **Arrow buttons** to enter the value for the selected section of the subnet mask

For details please refer to the description of the similar procedure in chap. 16.2.3 “Assigning the IP address”.

With the **arrow-down button** you can now change to the enter the standard gateway.

With the **Back button** you can go back to the “Ethernet” submenu and, repeatedly pressing it, to **Normal display**.

#### 16.2.5 Setting the standard gateway

Access to this function is possible only if manual IP address assignment has been selected (chap. 16.2.1)

Path: **Normal display**     **Settings**   **Ethernet**      **Standard gateway**

Press the **OK button** to enable the setting.

The standard gateway entry is done in four steps, corresponding to the number sections: (1).(2).(3).(4)

Principle of entry:

- Use the **OK button** to select the desired section of the standard gateway 1/4, 2/4, 3/4, 4/4 in the upper display line
- Use the **Arrow buttons** to enter the value for the selected section of the standard gateway
- For details please refer to the description of the similar procedure in chap. 16.2.3 “Assigning the IP address”.

With the **arrow-down button** you can now change to the assign the DNS server address.

With the **Back button** you can go back to the “Ethernet” submenu and, repeatedly pressing it, to **Normal display**.

## 16.2.6 Assigning the DNS server address

Access to this function is possible if manual IP address assignment (chap. 16.2.1) or manual DNS server address assignment (chap. 16.2.2) has been selected.

With manual IP address assignment:

Path: **Normal display**     **Settings**   **Ethernet**      **DNS server address**

With manual DNS server address assignment:

Path: **Normal display**     **Settings**   **Ethernet**    **DNS server address**

Press the **OK button** to enable the setting.

The DNS server address entry is done in four steps, corresponding to the number sections: (1).(2).(3).(4)

Principle of entry:

- Use the **OK button** to select the desired section of the DNS server address 1/4, 2/4, 3/4, 4/4 in the upper display line
- Use the **Arrow buttons** to enter the value for the selected section of the DNS server address
- For details please refer to the description of the similar procedure in chap. 16.2.3 "Assigning the IP address".

With the **Back button** you can go back to the "**Ethernet**" submenu and, repeatedly pressing it, to **Normal display**.

## 17. Data recorder

An internal data recorder saves chamber data and events in three data sets.

With the export function “Export recorder data” (chap. 18.3) you can save the three data sets via the USB interface to USB stick. They are issued in the selected language as a spreadsheet with the file extension “.csv” and can be further processed in the desired program. The data is unencrypted. Always the entire data memory is read out.

### 17.1 Recorded data

All data is given out in tabular form. The headlines of the values “number”, “date”, and “time” are given out in the selected language, all other information in English.

- **Chamber data for the user “DL1”**

Tabular representation of the actual temperature and CO<sub>2</sub> values together with the date and time, according to the set storage rate (chap. 17.3). Temperature values are always given out in °C.

- **Chamber data for BINDER Service “DL2”**

This data is intended for use by BINDER Service. It also contains information from the self-test function. The storage rate is fix (1 minute). Temperature values are always given out in °C.

- **Event list**

Messages regarding the controller and data memory as well as the alarm messages together with the date and time:

- Firmware update done
- “New config (USB)”: New configuration uploaded via USB
- “Data recorder cleared “ Data recorder and event list deleted via setup program
- Other event messages according to existing alarms
- The moment of switching the alarm state on and off is indicated under “On/Off”.

### 17.2 Storage capacity

The storage capacity of the data recorder depends on the number of entries.







- DL1 = 110.000 entries (equaling 76 days with a storage rate of 1 minute, setting see chap. 17.3)
- DL2 = 27.000 entries (equaling 18 days with a fix storage rate of 1 minute)
- Event list: 200 events

The shorter the set storage rate, the closer are the stored measuring points, the more precise, but also shorter is the documented period.

Once the storage capacity of the data recorder is reached, overwriting of the oldest values begins.

### 17.3 Setting the storage rate for the “DL1” recorder data

Required access level: “Admin”.

Path: **Normal display**     **Settings**    **Data recorder**  **Storage interval**

Press the **OK button** to enable the setting.

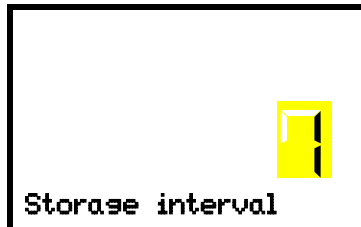

Function “Storage interval”.

The current setting flashes. Use the **arrow buttons** to enter the desired storage interval. Setting range: 1 minute to 60 minutes.

Press the **OK button** to confirm the setting.

With the **Back button** you can go back to the “**Data recorder**” submenu and, repeatedly pressing it, to **Normal display**.

### 17.4 Deleting the data recorder

When importing a configuration via USB stick (chap. 18.2) and when loading a new firmware version by BINDER service, the entire data memory is deleted.

BINDER service can also install the configuration by means of a setup program without deleting the data.

Regardless of this, BINDER Service can delete the data via a setup program

	<b>CAUTION</b>
	<p><b>Loading a new configuration via USB-Stick leads to deleting the data recorder. Danger of information loss.</b></p> <ul style="list-style-type: none"> <li>➤ Backup data prior to loading a new configuration.</li> </ul>

## 18. USB menu: Data transfer via USB interface

A USB interface for data transfer via USB stick is located in the instrument box (the second micro USB interface is only used by the manufacturer).

The controller offers an import function and three export functions through the USB interface:

### Import function (chap. 18.2):

- Configuration data in file "KONF380.set"

### Export functions (chap. 18.3):

- Configuration data in file "KONF380.set"
- Recorder data
  - DL1 (chamber data for the user): "DL1\_[MAC address of the chamber].csv"
  - DL2 (chamber data for BINDER Service): "DL2\_[MAC address of the chamber].csv"
  - Event list: "EvList\_[MAC address of the chamber].csv"

For detailed information on the file content see chap. 17.1.

- Service data

The "Service" folder is created on the USB stick and can be sent to BINDER Service. In addition to the configuration and recorder data, it contains further service-relevant information.

### 18.1 Connecting the USB stick

Connect the USB stick to the interface located in the triangular instrument panel.

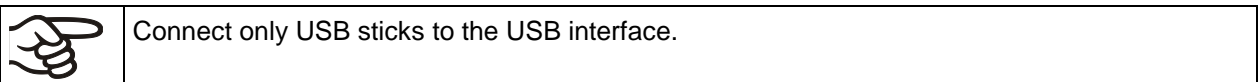

After inserting the USB stick, the initial function "Import configuration" is displayed.

As long as the USB stick is connected, only the functions for data transfer are available. Other controller functions are only available after removing the USB stick.

### 18.2 Import function

Required access level: "Admin".



Function "Import configuration".

To import configuration data from the USB stick, press the **OK button**.

With the **arrow-down button** you can now change to the setting of the "Export configuration" function.

### 18.3 Export functions

Required access level: any user



Function "Export configuration".

To write the configuration data from the controller to the USB stick, press the **OK button**.

With the **arrow-down button** you can now change to the next function.



Function "Export recorder data".

To write the recorder data from the controller to the USB stick, press the **OK button**.

With the **arrow-down button** you can now change to the next function.



Function "Export service data".

To write the chamber data from the controller to the USB stick, press the **OK button**.

### 18.4 Ongoing data transfer

A moving arrow symbol indicates the progress of the data transfer.

Example:



Data recording is running.

Attention! Danger of data loss! Do not disconnect the USB stick from the device during ongoing data transfer!

After successful transfer, the controller shows again the initial function "Import configuration".



## 18.5 Error during data transmission

In the event of an error, the message ERR (error) is displayed.



Read error (example).

## 18.6 Removing the USB stick

Logging off the USB stick is not possible / required.

Be sure that no data recording is running (chap. 18.4).

After removing the USB stick, the controller is back in the same menu as before when connecting the USB stick.

## 19. Reference measurements

You can take reference measurements of the temperature and CO<sub>2</sub> via the silicone measuring port (8) located the inner glass door. Reference temperature measurements always take place under equilibrated conditions with both doors closed.

### 19.1 CO<sub>2</sub> reference measuring

There are three possibilities to perform CO<sub>2</sub> test measurements between the recommended annual maintenance procedures. To test the CO<sub>2</sub> concentration inside an incubator, see chapters 19.1.1 to 19.1.3.

#### 19.1.1 Measuring the CO<sub>2</sub> concentration indirectly via the pH of the cell medium

By using the indirect determination of CO<sub>2</sub> concentration via the pH-value of the nutrient, it is possible to check the CO<sub>2</sub> concentration inside the chamber. This is a simple method to test the correct CO<sub>2</sub> concentration without any special CO<sub>2</sub> measuring equipment. You need only use an accurate pH indicator or a pH-measuring electrode, which are standard equipment in cell culture laboratories.



This method is not suitable for calibrating the BINDER FPI sensor system.

This method is based on the acid base equilibrium of the buffer system in the culture media.

NaHCO<sub>3</sub> buffers the common media. From the pH value of the medium, it is possible to conclude its CO<sub>2</sub> concentration. Figure 18 shows the relationship between CO<sub>2</sub> concentration in vol.-% and the pH of different NaHCO<sub>3</sub> buffered media.

#### Recommended procedure:

- Incubate an empty sample with medium for 1/2 day under the same conditions as the cells. You can perform the incubation in a cell culture bottle or in a 50 ml Falcon tube with open lid.
- After gassing, remove the empty sample from the incubator and within 5 minutes measure the pH-value with a glass electrode.

During the measurement, the medium should have the least possible surface contact with the ambient air, so that the CO<sub>2</sub> can evaporate only slightly. A significant downward movement will happen only after 5 minutes, permitting sufficient time for measurement.

- In addition, you can of course use pH-test strips (pH range 6 to 8, non-bleeding).

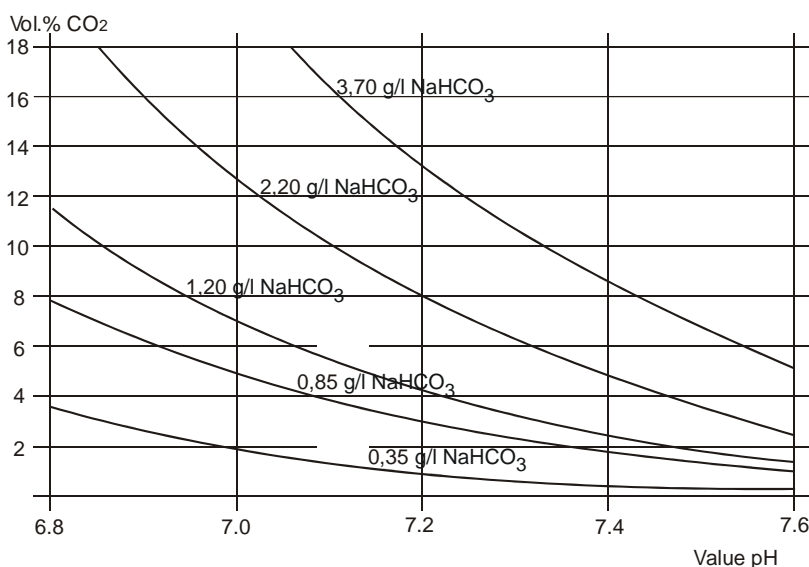

Trade names of common media:	
	NaHCO <sub>3</sub> [g/l]
DMEM	3.70
BME	2.20
MEM	2.20
Medium 199	2.20
Mc Coy	2.20
F10	1.20
F12	1.20

Figure 18: Value pH of NaHCO<sub>3</sub> buffered media as a function of the CO<sub>2</sub> concentration:

**Example:**

If a pH of 7.2 is measured in a medium buffered with 2.20 g NaHCO<sub>3</sub> per liter, there must be 8 vol.-% CO<sub>2</sub> surrounding this medium.

**19.1.2 Measuring CO<sub>2</sub> directly via chemical indicator tubes**

This is a common do-it-yourself test for many users. A chemical color reaction in a glass tube shows the CO<sub>2</sub> concentration. A standardized volume of air from inside the incubator has to be suctioned through this glass tube to get a quantitative test result. Therefore, use a special hand pump with a standardized suction volume.

**Procedure (example):**

- (1) Break off both ends of the glass tube or remove the plugs.
- (2) Pin the end with the higher end of the scale to the adapter of the hand pump that belongs to that test system.
- (3) Pin the other end through the silicone access port of the inner chamber door.
- (4) Take one sample volume out of the inner chamber volume by pressing the pump fully together and releasing it afterwards.
- (5) The standardized volume is suctioned through the glass tube and the chemical indicator changes its color beginning from the side pinned into the chamber in the direction of the hand pump.
- (6) The more CO<sub>2</sub> is inside the chamber the more the chemical reaction will cause a color change of the chemical reactor.
- (7) You can read the CO<sub>2</sub> concentration by the scale directly printed on the glass tube or a delivered reference-reading rule.
- (8) The result must then be corrected to the current ambient pressure. The required formula is printed on the instruction sheet of such systems.

All the necessary equipment must be supplied by one manufacturer only and in a defined test system.

Note: These test systems are not very accurate. A typical accuracy is around 10% of the full-scale value.

 These test systems are not suitable for calibrating the BINDER FPI sensor system.



Figure 19: Example of chemical indicator tubes



Figure 20: Example of a hand pump (foreground) and electrical pump (background)

### 19.1.3 Measuring CO<sub>2</sub> directly with an electronic infrared measuring device

The easiest way of measuring the CO<sub>2</sub> concentration is by electronic sensor systems. BINDER offers the portable measuring device model CTM 01 that was specifically designed to measure temperature and CO<sub>2</sub> concentration inside CO<sub>2</sub> incubators. The CTM 01 is suitable both for reference measurements in certified laboratories, and for service purposes. Please contact the BINDER INDIVIDUAL team.

## 19.2 Temperature reference measurement

When performing a temperature reference measurement using an electronic measuring, and temperature display device, it is important to use a device traceable to an acknowledged standards/calibration institution (DKD, PTB for Germany) with valid calibration certificate.

Note: The cable of the sensor must be thin enough to lay it over the door gasket of the incubator without causing any leakages.

## 20. Options

### 20.1 Silicone access ports 30 mm / 1.18 in, closable with 2 silicone plugs (8012-0558 rear, 8012-0559 left, 8012-0560 right) (option)

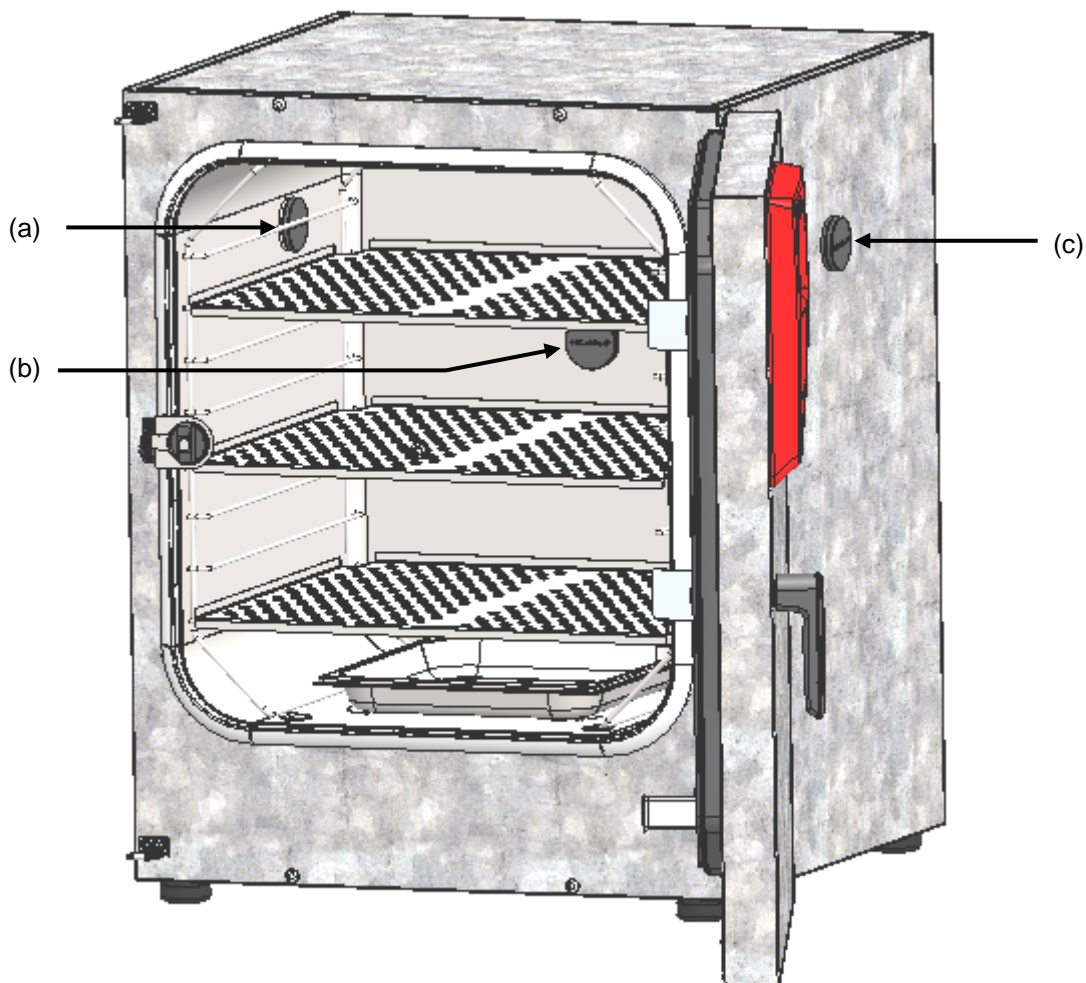



Figure 21: Positions of the optional silicon access ports left (a), rear (b), and right (c)

A warning sticker is located above each access port.

When operating a chamber with silicon access ports, both silicon plugs must tightly close the access ports. If the plugs are inserted in a not-gastight manner, or if plugs are missing, CO<sub>2</sub> gas may escape into the environment. The CO<sub>2</sub> control only turns off when the chamber door is opened.

	 <b>WARNING</b>
	<p><b>High concentration of CO<sub>2</sub> (&gt; 4 Vol.-%).</b>  <b>Risk of death by suffocation.</b>  <b>Danger of poisoning.</b></p> <p>➤ Tightly close each access port with two plugs during operation.</p>

## 20.2 Base on castors (option)

In order to obtain easy access to the incubator and to avoid contamination of the incubator caused by soil pollution, BINDER recommends using the base on castors.

	<p>The mounting instructions 7001-0147 delivered with the base on castors describe its installation (Art. No. 9051-0024).</p>
---	---

## 20.3 Stacking adapter for direct thermal decoupled stacking (option)

We recommend not stacking CO<sub>2</sub> incubators directly on top of one another in order to avoid transmission of shocks and vibrations from one chamber to the other. This could happen e.g. while opening or closing the door, cleaning, loading and unloading the chamber. BINDER offers a stacking adapter for direct thermal decoupled stacking of two incubators.

The stacking adapter ensures the exact maintenance of the set incubation parameters also during sterilization of the other chamber in the same stacking stand (chap. 23).

	<p>The mounting instructions 7001-0145 delivered with the stacking adapter describe its installation (Art. No. 9051-0025 for 2 C 170, Art. No. 9051-0027 for C 170 on top of CB 150/160).</p>
---	---

## 20.4 APT-COM™ 4 Multi Management Software (option)

The chamber is regularly equipped with an Ethernet interface (15) that can connect the BINDER APT-COM™ 4 Multi Management Software. The MAC Address is indicated in the “Ethernet” controller menu (chap. 16.1.1). The actual temperature and CO<sub>2</sub> values are given at adjustable intervals. Programming can be performed graphically via PC. Up to 100 chambers can be cross-linked. For further information please refer to the APT-COM™ 4 operating manual.

## 20.5 Data logger kit (option)

The BINDER Data Logger Kit offers an independent long-term measuring system for temperature. It is equipped with a keyboard and a large LCD display, alarm functions and a real-time function. Measurement data are recorded in the Data Logger and can be read out after the measurement via the RS232 interface of the Data Logger. It offers a programmable measuring interval and permits storing up to 64000 measuring values. Reading out is done with the Data Logger evaluation software. You can give out a combined alarm and status protocol directly to a serial printer.

**Data Logger Kit T 220:** Temperature range -90 °C / -130 °F up to +220 °C / 428 °F



For detailed information on installation and operation of the BINDER Data Logger, please refer to the mounting instructions Art. No. 7001-0204 and to the original user manual of the manufacturer, supplied with the data logger.

## 20.6 Analog outputs for temperature and CO<sub>2</sub> (option)

With this option, the CO<sub>2</sub> incubator is equipped with analog outputs 4-20 mA for temperature and CO<sub>2</sub>. These outputs allow transmitting data to external data registration systems or devices.

The connection is realized as a DIN socket at the rear of the CO<sub>2</sub> incubator as follows:



### **ANALOG OUTPUT 4-20 mA DC**

PIN 1: Temperature –  
PIN 2: Temperature +'  
PIN 3: CO<sub>2</sub> –  
PIN 4: CO<sub>2</sub> +

CO<sub>2</sub> range: 0 vol.-% up to 20 vol.-%  
Temperature range: 0 °C / 32 °F up to +200 °C / 392 °F

A suitable DIN plug is enclosed.

Figure 22: Pin allocation of DIN socket for option analog outputs

## 21. Avoiding microbial contamination

The main types of microbial contaminants in cell and tissue culture are bacteria, fungi, yeast, mycoplasma, and viruses. This chapter gives an overview of potential sources of contamination and precautions and measures to eliminate them.

### 21.1 Cells and media

- Primary cultures from the original tissue
- Cells/cell lines from unknown sources or from cell banks: Use only cells of known and tested origin. Monitoring and routine screening of new cultures.
- Media and sera: Use only sera of known and tested origin (mycoplasma free, e.g., UV or  $\gamma$  radiated).
- Virus suspensions, antibody solutions etc. Use only reagents of known and tested origin.
- Laboratory instruments, media and reagents, which were exposed to possible contaminated cultures must be sterilized / autoclaved / disposed.
- Antibiotics in the cell culture media may prevent bacteria detection: Use antibiotics selectively and economically.

### 21.2 Laboratory conditions / equipment around the CO<sub>2</sub> incubator

Possible sources of contamination in the cell culture lab are airborne germs, lab equipment, building features, and the lab personnel.

- Keep pipettes and instruments sterile after autoclaving.
- Bio safety cabinets (laminar air flow) should have a minimum of items apart from aspirator tube and burner. Items shall be positioned within easy reach and separate from each other. Disinfect surfaces with an alcohol-based disinfectant before and after use, clean the space underneath the bench, and carry out regular sterility tests of the filters.
- Regular cleaning / disinfection of laboratory equipment such as a centrifuge, microscope, water bath, refrigerator, and telephone.
- No equipment should be placed on the floor.
- Rough or humid walls are not suitable.
- Identify leaking doors and windows and make them airtight.
- Use air conditioning with special filters.
- Reduce the number of personnel and their movements in the lab by careful positioning all relevant equipment. For practical reasons, install the CO<sub>2</sub> incubator close to the laminar air flow bench.
- Regular microbiological monitoring of the cell culture laboratory.

### 21.3 Working and behavior in the lab

Sources of contamination are often the laboratory personnel themselves (surface germs, oral flora droplet transfer) and handling the equipment and cultures. We recommend staff training in aseptic techniques, laboratory safety and good laboratory practice (GLP).

### **Examples of general rules to reduce the contamination risks**

- Reduce hand germ count (wash hands with antimicrobial soap, dry with paper tissues, and rub dry hands with alcoholic solution).
- Wear appropriate clothing (work coat, shoes, face mask)
- Keep as few personnel as possible in the cell culture lab.

### **Examples of sterile working method**

- Work "clean-to-dirty", i.e., handle confirmed uncontaminated cells first, unknown or untested cells next, and lastly, if necessary, cells suspected to be contaminated.
- Perform daily microscopic observations of cultures and specific tests for the bacteria and fungi as part of a controlled routine. Test cultures for sterility before starting work.
- Keep working surfaces clean. Immediately wipe spilled liquids with alcohol solutions.
- No mouth contact on pipettes.
- Never work on top of open sterile containers.

## **21.4 Chamber design and equipment**

The design concepts behind the CO<sub>2</sub> incubator considerably reduce the risk of contamination. Among them are:

### **Even surfaces for easy manual cleaning**

- The inner surfaces are smooth and therefore easy to clean. The inner chamber is deep-drawn from a single piece of steel, polished (suitable for pharmaceutical work) and has no welds or inaccessible corners. The hinges and the seal of the inner glass door are glued from the outside, which also aids cleaning of the inner chamber.

### **Removable parts for cleaning and autoclaving**

- The shelves and the shelf holder are easily removed without screws. In this way, you can clean them hygienically in every laboratory dishwasher before hot-air sterilization. It is possible to autoclave the shelves. But this is generally not necessary because they can remain inside the incubator during sterilization.

### **Door gasket**

- The inner door gasket is removable and autoclavable.

### **Gas fine filter**

- The incoming gas used in the operation passes through a fine filter (aseptic filter, filtration efficiency 99.99%, particle size 0.45 µm) with a high filtration efficiency, which can also filter the smallest particles (chap. 24.3).

### **CO<sub>2</sub> measuring system in the inner chamber**

- You can remove the CO<sub>2</sub> sensor from the inner chamber by hand for disinfection (chap. 22.3).

### **Condensation prevention**

- Condensation in the inner chamber represents a particular risk of contamination. The humidifying system with water pan with integrated condensation point developed by BINDER is an effective and easy way to ensure high humidity (95 +/- 2% r.h.) inside the incubator without any condensation forming on the inner surfaces.

### **Hot air sterilization**

- The heating system of the chamber permits hot-air auto-sterilization (chap. 23). Thus, a temperature of 180 °C / 356°F is maintained for a 30-minute period on all internal surfaces during its cycle, resulting in sterilization of the entire inner chamber. Therefore, this procedure meets all international guidelines regarding hot air sterilization, e.g. AAMI ST63, DIN 58947, European Pharmacopoeia.



## 21.5 Handling the CO<sub>2</sub> incubator

Any manipulation of the CO<sub>2</sub> incubator involves some contamination risks, from installation to opening of the doors and regular cleaning.

### Installation away from sources of contamination

- Do not place the CO<sub>2</sub> incubator on the floor or close to windows and doors. Use the optional stand, if appropriate.

### Reduce the periods in which the door is open.

- Do not open the door too frequently.
- Placing items in order inside the incubator results in shorter door opening times.

### Water pan

- Fill the water pan with distilled, sterilized water (chap. 4.3). Never use ion exchange water; ion exchangers are propagation sites for bacteria.
- Clean and refill the pans 2 to 3 times a week. For evacuation, remove the water pan. It is autoclavable.
- If desired, you can add microbiologically inhibiting substances such as copper chips, copper sulphate or ethylene diamine tetra-vinegar acid (EDTA) in a concentration of 1 to 5 mmol/l.

### Avoiding condensation caused by ambient conditions

- Ambient room conditions have an effect on condensation inside the incubator, which can be caused by insufficient wall clearances, preventing even dissipation of heat, air movement or direct sunlight. If the temperature distribution inside the chamber becomes uneven, condensation may form on the cooler surfaces.
- Maintain distances from the wall: rear 100 mm / 3.94 in, sides 50 mm / 1.97 in.
- Do not place the chamber in front of a window. No direct sunlight. No air movement.
- Permissible ambient temperature range for operation: +18 °C / 64.4°F to +30 °C / 86°F. Ideal ambient temperature: at least 7 degrees below the intended working temperature. E.g., working temperature 37 °C / 98.6°F = ambient temperature 30 °C / 86°F and less.
- The incubator should be precisely calibrated / adjusted.

### Regular cleaning, decontamination, and sterilization



- Clean the shelves, glass door, gaskets, and inner chamber weekly (for cleaning see chap. 22.1, for decontamination see chap. 22.2). You can clean the shelves in a laboratory dishwasher and, if needed, individually autoclave them.
- Regularly use the hot air sterilization function (chap. 23) following cleaning. Shelves, shelf holders and the emptied water pan can remain inside the incubator during this operation.
- Replace the CO<sub>2</sub> sterile filter (once or twice a year depending on usage).

### What to do in case of contamination?

- Throw away / autoclave contaminated cultures.
- Carefully inspect cultures that seem to be uncontaminated.
- Clean the incubator as described. Wipe the inner chamber and the doors with a disinfectant and allow to dry. Autoclave the shelves. Empty the water pan and autoclave it.
- Perform hot air sterilization.

## 22. Cleaning, decontamination / disinfection, and sterilization

Clean the chamber after each use to avoid potential corrosion damage by ingredients of the charging material.

 	 <b>DANGER</b>
	<p><b>Electrical hazard.</b> <b>Danger of death.</b></p> <ul style="list-style-type: none"> <li>∅ Do NOT spill water or cleaning agents over the inner and outer surfaces.</li> <li>➤ Before cleaning, turn off the chamber at the main power switch (2) and disconnect the power plug.</li> <li>➤ Completely dry the appliance before turning it on again.</li> </ul>

### 22.1 Cleaning

Disconnect the CO<sub>2</sub> incubator from the power supply before cleaning. Disconnect the power plug.

	The interior of the chamber must be kept clean. Thoroughly remove any residues of the charging material.
---	--

Wipe the surfaces with a moistened towel. In addition, you can use the following cleaning agents:

Exterior surfaces, instrument panel:	Standard commercial cleaning detergents free from acid or halides. Alcohol-based solutions. We recommend using the neutral cleaning agent Art. No. 1002-0016.
Inner chamber, shelf holders, shelves, water pan:	Standard commercial cleaning detergents free from acid or halides. Copper sulphate solutions or alcohol-based solutions. We recommend using the neutral cleaning agent Art. No. 1002-0016.
CO <sub>2</sub> sensor	Alcohol-based solutions Do not immerse the CO <sub>2</sub> sensor into the solution. Disinfection with alcohol or an alcohol-based surface disinfectant without corrosive effect, free from acid or halides. We recommend using the disinfectant spray Art. No. 1002-0022.
Silicone door gasket:	Alcohol-based solutions or neutral cleaning agent Art. No. 1002-0016.
Zinc coated hinge parts, rear chamber wall	Standard commercial cleaning detergents free from acid or halides. Do NOT use a neutral cleaning agent on zinc coated surfaces.

Do not use cleaning agents that may cause a hazard due to reaction with components of the device or the charging material. If there is doubt regarding the suitability of cleaning products, please contact BINDER service.

	We recommend using the neutral cleaning agent Art. No. 1002-0016 for a thorough cleaning. Any corrosive damage that may arise following use of other cleaning agents is excluded from liability by BINDER GmbH.
---	---

	<b>CAUTION</b>
	<p><b>Danger of corrosion.</b> <b>Damage to the chamber.</b></p> <ul style="list-style-type: none"> <li>∅ Do NOT use acidic or chlorine cleaning detergents.</li> <li>∅ Do NOT use the neutral cleaning agent on other kind of surfaces e.g., the zinc coated hinge parts or the rear chamber wall.</li> </ul>

	For surface protection, perform cleaning as quickly as possible. After cleaning completely, remove any cleaning agents from the surfaces with a moistened towel. Let the chamber dry.
---	--



	Soapsuds may contain chlorides and must therefore NOT be used for cleaning.
---	---

	With every cleaning method, always use adequate personal safety controls.
---	---

Following cleaning, leave the chamber door open or remove the access port plugs.

	The neutral cleaning agent may cause health problems in contact with skin and if ingested. Follow the operating instructions and safety hints labeled on the bottle of the neutral cleaning agent.
---	--

Recommended precautions: To protect the eyes use sealed protective goggles. Suitable protective gloves with full contact: butyl or nitrile rubber, penetration time >480 minutes.

	 <b>CAUTION</b>
	<p><b>Contact with skin, ingestion.</b>  <b>Skin and eye damage due to chemical burns.</b></p> <ul style="list-style-type: none"> <li>Ø Do not ingest. Keep away from food and beverages.</li> <li>Ø Do NOT empty into drains.</li> <li>➤ Wear protective gloves and goggles.</li> <li>➤ Avoid skin contact.</li> </ul>

	Following use of the neutral cleaning agent and prior to hot-air sterilization, remove any agent residues by using a moistened towel in order to avoid formation of permanent residues.
---	---

## 22.2 Decontamination / chemical disinfection of the chamber

The operator must ensure that proper decontamination is performed in case a contamination of the chamber by hazardous substances has occurred.

Disconnect the CO<sub>2</sub> incubator from the power supply prior to chemical decontamination / disinfection. Pull the power plug.

Do not use decontamination agents that may cause a hazard due to reaction with components of the device or the charging material. If there is doubt regarding the suitability of cleaning products, please contact BINDER service.

You can use the following disinfectants:

Inner chamber	Standard commercial surface disinfectants free from acid or halides. Alcohol-based solutions. We recommend using the disinfectant spray Art. No. 1002-0022.
---------------	---

	For chemical disinfection, we recommend the disinfectant spray Art. No. 1002-0022. Any corrosive damage that may arise following use of other disinfectants is excluded from liability by BINDER GmbH.
---	--



With every decontamination / disinfection method, always use adequate personal safety controls.

In case of contamination of the interior by biologically or chemically hazardous material, there are two possible procedures depending on the type of contamination and charging material.

1. Spray the inner chamber with an appropriate disinfectant.

Before start-up, the chamber must be absolutely dry and ventilated, as explosive gases may form during the decontamination process.

2. You can sterilize the shelves and the shelf holder in a sterilizer or autoclave.



In case of eye contact, the disinfectant spray may cause eye damage due to chemical burns. Follow the operating instructions and safety hints labeled on the bottle of the disinfectant spray.

Recommended precautions: To protect the eyes use sealed protective goggles.



 **VORSICHT**

**Eye contact.**

**Eye damage due to chemical burns.**

- ∅ Do NOT empty into drains.
- Wear protective goggles.



Following frequent use of the disinfectant spray and prior to hot-air sterilization, remove any agent remainder by using the neutral cleaning agent and then a moistened towel to avoid formation of permanent residues.



After using the disinfectant spray, allow the incubator to dry thoroughly, and aerate it sufficiently.

## 22.3 Disinfection of the CO<sub>2</sub> sensor

To ensure complete disinfection and proper function of the sensor, BINDER recommends a wipe disinfection of the sensor head with pure alcohol or non-corrosive alcohol-based surface disinfectants. The disinfectant must be non-corrosive and free of chlorine or any acid. We recommend using the disinfectant Art. No. 1002-0022. Avoid strong shocks when handling the CO<sub>2</sub> sensor.

	<b>CAUTION</b>
	<p><b>Excess temperature.</b>  <b>Immersion of sensor into liquids.</b>  <b>Shocks of the CO<sub>2</sub> sensor.</b>  <b>Damage to the CO<sub>2</sub> sensor.</b></p> <ul style="list-style-type: none"> <li>⊘ Do NOT immerse the CO<sub>2</sub> sensor into liquids.</li> <li>⊘ Do NOT expose the CO<sub>2</sub> sensor to autoclaving.</li> <li>⊘ Do NOT expose the CO<sub>2</sub> sensor to hot-air sterilization.</li> <li>➤ Avoid strong shocks of the CO<sub>2</sub> sensor (by putting it down hard, or dropping).</li> </ul>

We recommend regular disinfection of the CO<sub>2</sub> sensor.

	<b>CAUTION</b>
	<p><b>Connecting or removing the CO<sub>2</sub> sensor during operation.</b>  <b>Damage to the CO<sub>2</sub> sensor.</b></p> <ul style="list-style-type: none"> <li>➤ Connect or remove the CO<sub>2</sub> sensor only with the chamber turned off.</li> </ul>

### Recommended procedure:

- Turn off the chamber
- Pull out the sensor
- Spray the sensor head with alcohol or wipe it clean with a soaked cloth. Observe the reaction time of the disinfectant used.
- Before reinserting the CO<sub>2</sub> sensor, it must be completely dry.
- The filter in the front of the sensor only needs replacing when damaged or dirty.

The CO<sub>2</sub> sensor head was especially adjusted for the specific chamber. To avoid confusion, an adhesive label with a serial number is adhered to the sensor head. When exchanging the sensor, repeat CO<sub>2</sub> adjustment.

	<b>CAUTION</b>
	<p><b>Different CO<sub>2</sub> sensor.</b>  <b>Invalid calibration.</b></p> <ul style="list-style-type: none"> <li>⊘ Do NOT change the CO<sub>2</sub> sensor head.</li> <li>➤ Write down the serial number of the CO<sub>2</sub> sensor.</li> </ul>

## 23. Hot-air sterilization at 180 °C / 356 °F



The very first sterilization after operation may cause an odor. This is not a quality defect. We recommend ventilating well the room during sterilization.

### 23.1 Overview

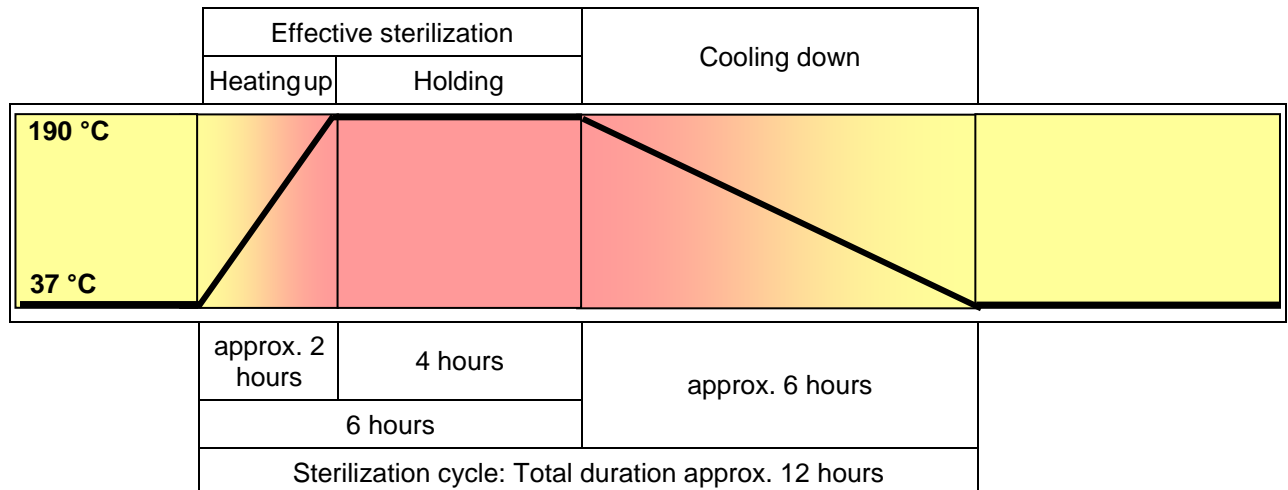

Figure 23: Temperature set-point profile and phases of the sterilization cycle

The chamber can perform an automatically controlled hot-air sterilization cycle. This procedure will take approx. 12 hours and consists of the following steps:

- **Heating up phase:** The incubator heats up the inner chamber as fast as possible to the sterilization set-point temperature
- **Holding phase:** Constant sterilization set-point temperature

The sterilization set-point temperature is pre-set in factory to 190 °C / 374 °F. When this temperature is reached, the holding phase begins. The duration of the holding phase is in total 4 hours. This ensures that 180 °C / 356 °F is maintained on all internal surfaces for at least 30 minutes.

The effective sterilization phase consists of the heating up and holding phase with a total duration of 6 hours. The necessary duration for the proper sterilization is then completed. A cooling-down phase follows.

- **Cooling down phase:** Cooling down to 37 °C / 98.6°F. It starts 6 hours after begin of the sterilization cycle.

As soon as the cooling down phase starts, the information message “Sterilization success” indicates the successful sterilization.

The precise duration of the entire sterilization cycle depends on the ambient temperature at the installation site and can thus vary. At an ambient temperature of 25 °C / 77 °F, the total duration is approx. 12 hours. You can shorten the cooling-down time by prematurely terminating the sterilization cycle (chap. 23.4) during the cooling-down phase, i.e. no sooner than after 6 hours.

During sterilization, the CO<sub>2</sub> valve is closed and the CO<sub>2</sub> controller turns off entirely.

## 23.2 Performing a hot-air sterilization

### 23.2.1 Preparations for hot-air sterilization

	<p>Before carrying out the first hot-air sterilization, remove any protective lamination sheet from the inner metal surfaces.</p>
---	---

- Turn off the chamber
- Pull out the CO<sub>2</sub> sensor without any rotation from the connection socket in the upper part of the rear and remove it from the inner chamber.



**The CO<sub>2</sub> sensor is temperature resistant up to a maximum temperature of 60 °C / 140 °F. It is therefore required to remove it before performing a hot-air sterilization.**

	<p style="text-align: center;"><b>CAUTION</b></p> <p><b>Excess temperature.</b> <b>Damage to the CO<sub>2</sub> sensor.</b></p> <p>⊘ Do NOT expose the CO<sub>2</sub> sensor to hot-air sterilization.</p>
---	--

The CO<sub>2</sub> sensor head was especially adjusted for your specific chamber. To avoid confusion, an adhesive label with a serial number is adhered to the sensor head. When exchanging the sensor, repeat CO<sub>2</sub> control adjustment.

	<p style="text-align: center;"><b>CAUTION</b></p> <p><b>Different CO<sub>2</sub> sensor.</b> <b>Invalid calibration.</b></p> <p>⊘ Do NOT change the CO<sub>2</sub> sensor head. ➤ Write to down the serial number of the CO<sub>2</sub> sensor.</p>
--	---

- Empty the water pan.

	<p style="text-align: center;"> <b>WARNING</b></p> <p><b>Danger of implosion.</b> <b>Damage to the chamber.</b></p> <p>➤ Empty the water pan before starting the hot-air sterilization.</p>
---	--

- Clean the chamber.
- Water pan, shelf holder, and shelves must be inside the incubator, the water pan at its usual place on the bottom.

	<p>Before starting a hot-air sterilization, the entire interior must be clean and dry. No residue of e.g., water, medium or plastic must remain inside the chamber.</p>
---	---

- Close the inner glass door and the outer chamber door.
- Turn on the chamber.
- Activate the sterilization procedure (chap. 23.3.1).

### 23.3 Starting and running the hot-air sterilization cycle

Make sure that before starting the hot-air sterilization the following is done:

- The water pan was emptied
- All samples were removed from the chamber
- The CO<sub>2</sub> sensor is disconnected

#### 23.3.1 Starting sterilization

Required access level: "User".

Path: **Normal display**  **Sterilization**



"Sterilization" menu.  
In this menu you can start a sterilization or stop a running sterilization.

With the **Back button** you can go back to **Normal display**.

Press the **OK button** to enter the sterilization submenu.

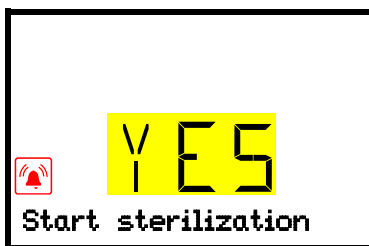

"Start sterilization" submenu  
The current setting flashes. Select with the **arrow buttons** between YES (start sterilization) and NO (do not start sterilization).  
To start the sterilization cycle select "YES" and press the **OK button** to confirm.

After selecting "NO": The controller changes back to the "Sterilization" menu.

After selecting "YES": Sterilization starts and the controller changes to Normal display.

No sterilization can be started if the CO<sub>2</sub> sensor is still plugged-in. The information message ""CO<sub>2</sub> sensor plugged-in" appears and the controller returns to Normal display.

#### 23.3.2 Performance during sterilization

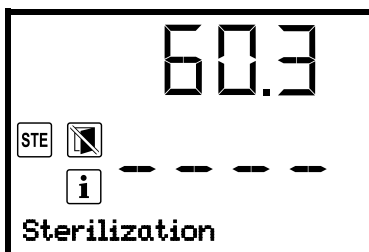

Normal display during sterilization (example during heating up phase)

The information message "Sterilization" is shown alternating with the indication "Temp. / CO<sub>2</sub>".

The CO<sub>2</sub> actual value display shows "----" because the CO<sub>2</sub> sensor is disconnected.

The zero-voltage relay alarm output and the buzzer are not activated.



	When starting a hot-air sterilization, CO <sub>2</sub> control deactivates automatically.
---	---

	The safety controller settings are inactive during sterilization. They become functional again following termination of the sterilization and/or restarting the chamber at the main power switch.
---	---

	<b>CAUTION</b>
	<p><b>The glass door and inner chamber become hot during sterilization.</b>  <b>Danger of burning.</b></p> <p>∅ Do NOT touch the glass door and inner surfaces during sterilization.</p>

Opening the outer door leads to prematurely terminating the running sterilization cycle (chap. 23.5). If this happens during the heating up or holding phase (during 6 hours after starting the sterilization cycle), sterilization will be ineffective (chap. 23.4.1).

	<b>CAUTION</b>
	<p><b>Opening the outer door during the heating up or holding phase.</b>  <b>Interruption of the temperature reaction time.</b>  <b>Ineffective sterilization.</b></p> <p>∅ Do NOT open the chamber doors during the heating up or holding phase of the sterilization cycle</p>

### 23.3.3 Completing the entire sterilization cycle

After 6 hours the information message “Sterilization success” indicates the successful sterilization. The cooling down phase starts.

The entire sterilization cycle ends after a total of approx. 12 hours.

- When the inner chamber has cooled down to a value below 60 °C / 140 °F, turn off the chamber and plug in the CO<sub>2</sub> sensor.

	The CO <sub>2</sub> sensor is temperature resistant up to a maximum temperature of 60 °C / 140 °F
---	---

- Start up the chamber (chap. 6)

The chamber is now ready to operate.

## 23.4 Prematurely terminating the sterilization cycle – effects

Prematurely terminating the sterilization cycle means terminating it before the entire 12-hour duration is completed. Whether effective sterilization has occurred depends on the time that has elapsed before.



- Premature termination after less than 6 hours: Prevents effective sterilization.  
This is indicated by the alarm message “Sterilization failed”.
- Premature termination after more than 6 hours: The chamber is definitely in the cooling-down phase, meaning that the necessary duration for the proper sterilization phase has occurred.  
This is indicated by the information message “Sterilization success”.

### 23.4.1 Premature termination after less than 6 hours: Ineffective sterilization

When prematurely terminating the sterilization cycle, it may be that the cells/pathogens inside the chamber have not all been killed. If necessary, you should repeat the sterilization.

	<b>CAUTION</b>
	<p><b>Interruption of temperature reaction time.</b> <b>Ineffective sterilization.</b></p> <p>➤ If necessary, repeat the sterilization.</p>

The interior may still be hot.

	 <b>CAUTION</b>
	<p><b>Glass door and inner chamber become hot during sterilization.</b> <b>Danger of burning.</b></p> <p>⊘ Do NOT touch the glass door and inner surfaces for approx. 7 hours after prematurely terminating the sterilization cycle.</p>

- When the inner chamber has cooled down to a value below 60 °C / 140 °F, turn off the chamber and plug in the CO<sub>2</sub> sensor.



	The CO <sub>2</sub> sensor is temperature resistant up to a maximum temperature of 60 °C / 140 °F
---	---

- Start up the chamber (chap. 6).

### 23.4.2 Premature termination after more than 6 hours, i.e., during the cooling-down phase: successful sterilization

The duration of the entire sterilization is approx. 12 hours. If you want to shorten the sterilization procedure in order to save time, you can prematurely terminate it during the cooling-down phase, i.e. no sooner than after 6 hours. At this point, the inner temperature is still approx. 140 °C / 284 °F.

The effective sterilization phase (heating up and holding phase) is automatically finished after 6 hours. The chamber is in the cooling-down phase, meaning that the necessary duration for the proper sterilization has occurred.

	 <b>CAUTION</b>
	<p><b>Glass door and inner chamber become hot during sterilization.</b> <b>Danger of burning.</b></p> <p>⊘ Do NOT touch the glass door and inner surfaces for approx. 4 hours after prematurely terminating the sterilization cycle.</p>

## 23.5 Prematurely terminating the sterilization cycle – procedure

Three events lead to terminating the sterilization cycle prematurely:

- Cancelling sterilization via the controller menu (chap. 23.5.1)
- Opening the outer door (chap. 23.5.2)
- Turning off the chamber at the main power switch (chap. 23.5.3) or a power failure

### 23.5.1 Cancelling sterilization via the controller menu

Required access level: “User”.

Path: **Normal display**  **Sterilization**

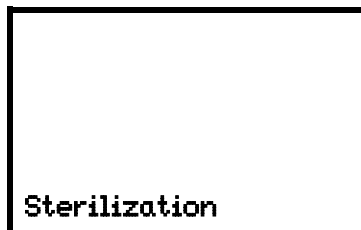

“Sterilization” menu.  
In this menu you can start a sterilization or stop a running sterilization.

With the **Back button** you can go back to **Normal display**.

Press the **OK button** to enter the sterilization submenu.

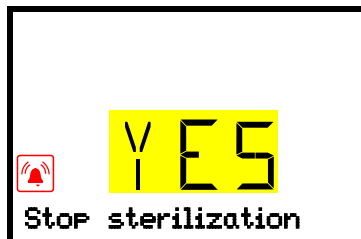

“Stop sterilization” submenu.  
The current setting flashes. Select with the **arrow buttons** between YES (stop sterilization) and NO (do not stop sterilization).  
To stop the sterilization select “YES” and press the **OK button** to confirm.

After selecting “NO”: The controller changes back to the “Sterilization” menu.

After selecting “YES”: The controller changes to Normal display. The sterilization is terminated. If termination occurred after less than 6 hours, the alarm message “Sterilization failed” is indicated until pressing the **OK button**.

- Do not open the chamber doors until the interior temperature has dropped to 37 °C / 98.6 °F.
- After premature termination the chamber reverts to its standard operational status.
- The CO<sub>2</sub> actual value display shows “ – – – – ” because the CO<sub>2</sub> sensor is disconnected.

As long as the interior temperature remains above the temperature set to trigger the temperature alarm, the chamber will trigger alarm signals. You can ignore this alarm and turn off the buzzer of the safety controller by pressing the **OK button**.

- If necessary, repeat the sterilization.
- When the inner chamber has cooled down to a value below 60 °C / 140 °F, turn off the chamber and plug in the CO<sub>2</sub> sensor.



The CO<sub>2</sub> sensor is temperature resistant up to a maximum temperature of 60 °C / 140 °F

- Start up the chamber (chap. 6).

### 23.5.2 Opening the outer door

For safety reasons, the sterilization cycle is automatically aborted if you open the outer chamber door.

- Do not open the glass door and close the outer door immediately.
- After premature termination caused by opening the outer door the chamber reverts to its standard operational status.
- The CO<sub>2</sub> actual value display shows “ – – – – ” because the CO<sub>2</sub> sensor is disconnected.

As long as the interior temperature remains above the temperature set to trigger the temperature alarm, the chamber will trigger alarm signals. You can ignore this alarm and turn off the buzzer of the safety controller by pressing the **OK button**.

- If necessary, repeat the sterilization.
- When the inner chamber has cooled down to a value below 60 °C / 140 °F, turn off the chamber and plug in the CO<sub>2</sub> sensor.



The CO<sub>2</sub> sensor is temperature resistant up to a maximum temperature of 60 °C / 140 °F

- Start up the chamber (chap. 6).

### 23.5.3 Turning off the chamber

For safety reasons, the sterilization cycle is aborted if the chamber is turned off or if there is a power failure.

Normally you should not terminate sterilization in this way.

- Do not open the chamber doors until the interior temperature has dropped to 37 °C / 98.6 °F.
- After turning on again the chamber at the main power switch, it will revert to its standard operational status.
- The CO<sub>2</sub> actual value display shows “ – – – – ” because the CO<sub>2</sub> sensor is disconnected.

As long as the interior temperature remains above the temperature set to trigger the temperature alarm, the chamber will trigger alarm signals. You can ignore this alarm and turn off the buzzer of the safety controller by pressing the **OK button**.

- If necessary, repeat the sterilization.
- When the inner chamber has cooled down to a value below 60 °C / 140 °F, turn off the chamber and plug in the CO<sub>2</sub> sensor.





The CO<sub>2</sub> sensor is temperature resistant up to a maximum temperature of 60 °C / 140 °F

- Start up the chamber (chap. 6).

## 24. Maintenance, and service

### 24.1 Maintenance intervals, service

 	 <b>DANGER</b>
<p><b>Electrical hazard.</b> <b>Danger of death.</b></p> <ul style="list-style-type: none"> <li>⊘ The chamber must NOT become wet during operation or maintenance work.</li> <li>⊘ Do NOT remove the chamber's rear panel.</li> <li>➤ Before conducting maintenance work, turn off the chamber at the main power switch (2) and disconnect the power plug</li> <li>➤ Ensure all maintenance work is conducted by licensed electricians or experts authorized by BINDER.</li> </ul>	

Ensure regular maintenance work is performed at least once a year.

	The warranty becomes void if maintenance work is conducted by non-authorized personnel.
---	---

	Replace the door gasket only when cold. Otherwise, the door gasket may become damaged.
---	--

The CO<sub>2</sub> sensor was especially adjusted for the specific chamber. When exchanging the sensor, you must repeat the CO<sub>2</sub> adjustment.

We recommend taking out a maintenance agreement. Please consult BINDER Service.

BINDER telephone hotline:	+49 (0) 7462 2005 555
BINDER fax hotline:	+49 (0) 7462 2005 93555
BINDER e-mail hotline:	service@binder-world.com
BINDER service hotline USA:	+1 866 885 9794 or +1 631 224 4340 x3 (toll-free in the USA)
BINDER service hotline Asia Pacific:	+852 390 705 04 or +852 390 705 03
BINDER service hotline Russia and CIS	+7 495 988 15 16
BINDER Internet website	<a href="http://www.binder-world.com">http://www.binder-world.com</a>
BINDER address	BINDER GmbH, post office box 102, D-78502 Tuttlingen

International customers, please contact your local BINDER distributor.

### 24.2 Service Reminder

You can display the time until the service due in the controller. Keep the **OK button** pressed down for 5 seconds.

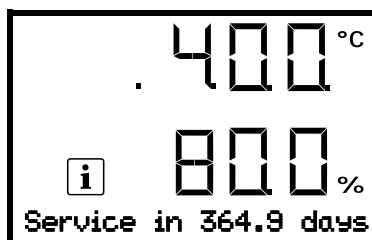

The remaining time in days until maintenance is due is shown in the text field of the controller display.  
Press the **OK button** to confirm the message.

After the recommended maintenance interval (one year of operation) a message appears on the controller.

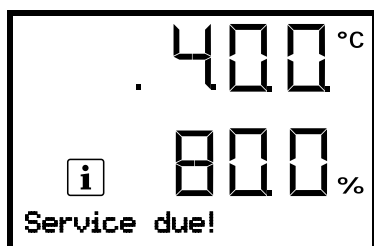

The information message "Service due!" is shown in the text field of the controller display.  
Press the **OK button** to confirm the message.

After one week of operation, the message reappears.

### 24.3 Gas inlet fine filter

When the chamber is operating, the incoming gas passes through a fine gas filter (aseptic filter, filtration efficiency 99.99%, particle size 0.45 µm). The gas fine filter prevents dirt accumulating in the gas inlet valves and the tubes leading into the inner chamber, which could be in the gas cylinder or in the supply tubes.

Service personnel authorized by BINDER will check this filter for pollution at each maintenance interval and replace it, if appropriate, but at least once a year.

### 24.4 Sending the chamber back to BINDER GmbH

If you return a BINDER product to us for repair or any other reason, we will only accept the product upon presentation of an **authorization number** (RMA number) that has previously been issued to you. An authorization number will be issued after receiving your complaint either in writing or by telephone **prior** to your sending the BINDER product back to us. The authorization number will be issued following receipt of the information below:

- BINDER product type and serial number
- Date of purchase
- Name and address of the dealer from which you bought the BINDER product
- Exact description of the defect or fault
- Complete address, contact person and availability of that person
- Exact location of the BINDER product in your facility
- A contamination clearance certificate (chap. 30) must be faxed in advance

The authorization number must be applied to the packaging in such a way that it can be easily recognized or be recorded clearly in the delivery documents.



For security reasons we cannot accept a chamber delivery if it does not carry an authorization number.

**Return address:**

BINDER GmbH  
Abteilung Service

Gänsäcker 16  
78502 Tuttlingen  
Germany

## 25. Disposal

### 25.1 Disposal of the transport packing

#### 25.1.1 Outer chamber packing

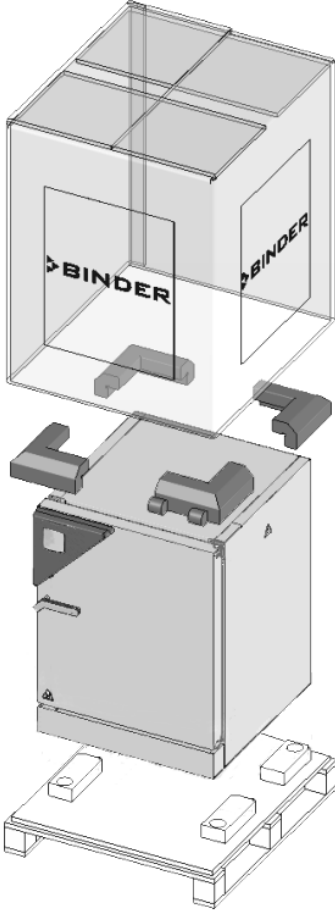
Packing element	Material	Disposal	
	Straps to fix packing on pallet (no image)	Plastic Plastic recycling	
	Shipping box	Cardboard Paper recycling	
	Edge stuffing, top	PE foam Plastic recycling	
	Pallet with foamed plastic stuffing	PE foam	Plastic recycling
		Solid wood (IPPC standard)	Wood recycling

#### 25.1.2 Packing inside the chamber, equipment

Packing element	Material	Disposal
Door protection	PE foam	Plastic recycling
Packing box equipment	Cardboard	Paper recycling
Insulating air cushion foil	PE foil	Plastic recycling
Paperboard	Cardboard	Paper recycling
Silica gel bag	Paper with silica gel	Do not open. Dispose of with normal waste
Sensor packing	Cardboard	Paper recycling
	PE foam	Plastic recycling
Bag for operating manuals	PE foil	Plastic recycling



If recycling is not possible, all packing parts can also be disposed of with normal waste.

## 25.2 Decommissioning

- Turn off the main power switch (2) and disconnect the chamber from the power supply (pull the power plug).
- Turn off the CO<sub>2</sub> supply. Remove the gas connection.
- Let the inner chamber sufficiently cool down before removing any parts.
- The water pan must not remain filled while the incubator is out of operation. Otherwise condensation may occur on the inner surfaces, as well as in the injection and suction nozzle of the CO<sub>2</sub> sensor compartment. If condensation formation has occurred, drops of condensate would leak from the openings of injection and suction nozzle of the CO<sub>2</sub> sensor. In this case, clean and dry the incubator running at 37 °C / 98.6 °F with doors open for at least one hour before loading it with samples. BINDER recommends performing a hot air sterilization of the chamber before commissioning.
- Disassembling the shelf holder takes place inside the chamber. Remove the shelves. Then fold both lateral parts to the middle and remove them.



You cannot take out the shelf holder of the incubator entirely together with the shelves.

- Temporal decommissioning: See indications for appropriate storage, chap. 3.3.
- Final decommissioning: Dispose of the chamber as described in chap. 25.3 to 25.5.

When restarting the chamber, please pay attention to the corresponding information in chap. 6.3.

## 25.3 Disposal of the chamber in the Federal Republic of Germany

According to Annex I of Directive 2012/19/EU of the European Parliament and of the Council on waste electrical and electronic equipment (WEEE), BINDER devices are classified as “monitoring and control instruments” (category 9) only intended for professional use“. They must not be disposed of at public collecting points.

The chambers bear the symbol for the marking of electrical and electronic equipment manufactured / placed on the market in the EU after 13 August 2005 and be disposed of in separate collection according to Directive 2012/19/EU on waste electrical and electronic equipment (WEEE) and German national law for electrical and electronic equipment (Elektro- und Elektronikgerätegesetz, ElektroG). WEEE marking: crossed-out wheeled bin with solid bar under. A significant part of the materials must be recycled in order to protect the environment.

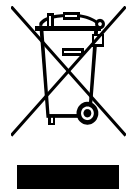



At the end of the device's service life, have the chamber disposed of according to the German national law for electrical and electronic equipment (Elektro- und Elektronikgerätegesetz, ElektroG from 20 October 2015, BGBl. I p. 1739) or contact BINDER service who will organize taking back and disposal of the chamber according to the German national law for electrical and electronic equipment (Elektro- und Elektronikgerätegesetz, ElektroG from 20 October 2015, BGBl. I p. 1739).

	<b>CAUTION</b>
	<p><b>Violation against existing law.</b></p> <ul style="list-style-type: none"> <li>⊘ Do NOT dispose of BINDER devices at public collecting points.</li> <li>➤ Have the device disposed of professionally at a recycling company which is certified according to the German national law for electrical and electronic equipment (Elektro- und Elektronikgerätegesetz, ElektroG from 20 October 2015, BGBl. I p. 1739).</li> <li style="text-align: center;"><i>or</i></li> <li>➤ Instruct BINDER Service to dispose of the device. The general terms of payment and delivery of BINDER GmbH apply, which were valid at the time of purchasing the chamber.</li> </ul>



Certified companies disassemble waste (used) BINDER equipment in primary substances for recycling according to Directive 2012/19/EU. The devices must be free from toxic, infectious or radioactive substances in order to eliminate any health hazards to the employees of the recycling companies.

	<p>Prior to handing the chamber over to a recycling company, it is the user's responsibility that it is free from toxic, infectious or radioactive substances.</p> <ul style="list-style-type: none"> <li>• Prior to disposal, clean all introduced or residual toxic substances from the chamber.</li> <li>• Prior to disposal, disinfect the chamber from all sources of infection. Be aware that sources of infection may also be located outside the inner chamber.</li> <li>• If you cannot safely remove all toxic substances and sources of infection from the chamber, dispose of it as "special" waste according to national law.</li> <li>• Fill out the contamination clearance certificate (chap. 30) and enclose it with the chamber.</li> </ul>
---	---

	 <b>WARNING</b>
	<p><b>Contamination of the device with toxic, infectious or radioactive substances.</b>  <b>Danger of intoxication.</b>  <b>Danger of infection.</b></p> <ul style="list-style-type: none"> <li>⊘ NEVER take a chamber contaminated with toxic substances or sources of infection for recycling according to Directive 2012/19/EU.</li> <li>➤ Prior to disposal, remove all toxic substances and sources of infection from the chamber.</li> <li>➤ A chamber from which all toxic substances or sources of infection cannot be safely removed must be considered as "special" waste according to national law. Dispose of it accordingly.</li> </ul>

## 25.4 Disposal of the chamber in the member states of the EU except for the Federal Republic of Germany

According to Annex I of Directive 2012/19/EU of the European Parliament and of the Council on waste electrical and electronic equipment (WEEE), BINDER devices are classified as "monitoring and control instruments" (category 9) only intended for professional use". They must not be disposed of at public collecting points.

The chambers bear the symbol for the marking of electrical and electronic equipment manufactured / placed on the market in the EC after 13 August 2005 and be disposed of in separate collection according to the Directive 2012/19/EU on waste electrical and electronic equipment (WEEE). WEEE marking: crossed-out wheeled bin with solid bar under.

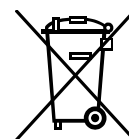



At the end of the device's service life, notify the distributor who sold you the device, who will take back and dispose of the chamber according to the Directive 2012/19/EU on waste electrical and electronic equipment (WEEE).

	<b>CAUTION</b>
	<p><b>Violation against existing law.</b></p> <ul style="list-style-type: none"> <li>⊘ Do NOT dispose of BINDER devices at public collecting points.</li> <li>➤ Have the device disposed of professionally at a recycling company that is certified according to conversion of the Directive 2012/19/EU into national law. <i>or</i></li> <li>➤ Instruct the distributor who sold you the device to dispose of it. The agreements apply that were agreed with the distributor when purchasing the chamber (e.g. his general terms of payment and delivery).</li> <li>➤ If your distributor is not able to take back and dispose of the chamber, please contact BINDER service.</li> </ul>

Certified companies disassemble waste (used) BINDER equipment in primary substances for recycling according to Directive 2012/19/EU. The devices must be free from toxic, infectious or radioactive substances in order to eliminate any health hazards to the employees of the recycling companies.

	<p>Prior to handing the chamber over to a recycling company, it is the user's responsibility that it is free from toxic, infectious or radioactive substances.</p> <ul style="list-style-type: none"> <li>• Prior to disposal, clean all introduced or residual toxic substances from the chamber.</li> <li>• Prior to disposal, disinfect the chamber from all sources of infection. Be aware that sources of infection may also be located outside the inner chamber.</li> <li>• If you cannot safely remove all sources of infection and toxic substances from the chamber, dispose of it as "special" waste according to national law.</li> <li>• Fill out the contamination clearance certificate (chap. 30) and enclose it with the chamber.</li> </ul>
---	---

	<div style="background-color: #FFA500; text-align: center; padding: 5px;"> <b>WARNING</b></div> <p><b>Contamination of the device with toxic, infectious or radioactive substances.</b>  <b>Danger of intoxication.</b>  <b>Danger of infection.</b></p> <ul style="list-style-type: none"> <li>⊘ NEVER take a chamber contaminated with toxic substances or sources of infection for recycling according to Directive 2012/19/EU.</li> <li>➤ Prior to disposal, remove all toxic substances and sources of infection from the chamber.</li> <li>➤ A chamber from which all toxic substances or sources of infection cannot be safely removed must be considered as "special" waste according to national law. Dispose of it accordingly.</li> </ul>
---	---

## 25.5 Disposal of the chamber in non-member states of the EU

	<div style="background-color: #FFFF00; text-align: center; padding: 5px;"><b>CAUTION</b></div> <p><b>Alteration of the environment.</b></p> <ul style="list-style-type: none"> <li>➤ For final decommissioning and disposal of the CO<sub>2</sub> incubator, please contact BINDER Service.</li> <li>➤ Follow the statutory regulations for appropriate, environmentally friendly disposal.</li> </ul>
---	--

The main board of the CO<sub>2</sub> incubator includes a lithium cell. Please dispose of it according to national regulations.

## 26. Troubleshooting

### 26.1 General

No.	Fault description	Possible cause	Required measures
1	Chamber without function.	No power supply.	Check connection to power supply.
		Wrong voltage.	Check power supply for voltage of 120 V / 230 V.
		Nominal temperature exceeded by 10 °C due to chamber failure. Over temperature protective device (class 1) responds (chap. 11.1).	Contact BINDER service.
		The miniature fuse for overcurrent protection has triggered (chap. 27.2).	Check chamber fuse and replace it if appropriate. If it responds again, contact BINDER service.
		Controller defective.	Contact BINDER service.
2	Set-point values are not equilibrated. Icon "1" is displayed.	Operating mode "Idle mode" activated.	Deactivate operating mode "Idle mode" (chap. 9.1)
3	Alarm message "Door open".	The outer chamber door is open	Close chamber door.

### 26.2 Temperature

No.	Fault description	Possible cause	Required measures
1	Chamber does not heat up.	Pt 100 sensor defective.	Contact BINDER service.
		Heating element defective.	
		Semiconductor relay defective.	
2	Chamber is heating permanently. Set-point is not respected.	Semiconductor relay defective.	Contact BINDER service.
3	Temperature inside too low.	Doors not closed.	Close door properly.
		Door gaskets defective.	Replace door gaskets.
		Controller defective.	Contact BINDER service.
		Pt 100 sensor defective.	
		Controller not adjusted.	
4	Temperature inside too low. Alarm message "Temperature range"	Current actual temperature value outside the tolerance range. For causes and actions, see no. 3.	Operation temporarily possible. Check the tolerance range settings. With other error messages remove the respective cause.
5	Temperature inside too high.	Installation site too warm.	Select cooler place of installation (chap. 3.4).
		Difference between the set temperature and the ambient temperature too low.	Difference between the set temperature and the ambient temperature at least 6 °C.
		Too much external heat load.	Reduce heat load.
		Controller defective.	Contact BINDER service.
		Semiconductor relay defective.	
		Controller not adjusted.	

No.	Fault description	Possible cause	Required measures
6	Temperature inside too high. Alarm message "Temperature range"	Current actual temperature value outside the tolerance range. For causes and actions, see no. 5.	Operation temporarily possible. Check the tolerance range settings. With other error messages remove the respective cause.
7	Alarm message "Safety controller"	Safety controller (chap. 11.2) set too low.	Check the setting of the safety controller. If appropriate, select suitable safety controller value (chap. 11.2).
		Sterilization terminated prematurely.	Let the chamber cool down.
8	Actual temperature value display shows " - - - -". Alarm message "Inner temp. sensor"	Inner temperature sensor defective. Control continues using the safety controller temperature sensor.	Operation temporarily possible. Contact BINDER service.
9	Alarm messages "Safety controller" and "Safety control sensor" alternating	Safety controller temperature sensor defective.	Turn off the chamber. Contact BINDER service.
10	Actual temperature value display shows " - - - -". Alarm messages "Inner temp. sensor", "Safety controller", and "Safety control sensor" alternating	Inner temperature sensor and safety controller temperature sensor defective.	Turn off the chamber. Contact BINDER service.
11	Alarm message "Door heating sensor"	Door heating sensor defective.	Contact BINDER service.

### 26.3 CO<sub>2</sub>

No.	Fault description	Possible cause	Required measures
1	CO <sub>2</sub> set-point values are not equilibrated. Icon "2" is displayed.	CO <sub>2</sub> control is deactivated.	Activate CO <sub>2</sub> control (chap. 9.2)
2	Alarm message "CO <sub>2</sub> pressure".	CO <sub>2</sub> cylinder is not connected correctly.	Correctly connect the gas cylinder.
		Connected gas cylinder is closed or empty.	Open or replace gas cylinder.
		Gas hose is dirty or obstructed.	Check the tube system for dirt accumulation or obstruction, clean or replace it.
		Pressure sensor system defective	Contact BINDER service.
3	CO <sub>2</sub> concentration inside too low.	Doors not closed.	Close door properly.
		Door gaskets defective.	Replace door gaskets.
		CO <sub>2</sub> cylinder is not connected correctly.	Correctly connect the gas cylinder.
		Connected gas cylinder is closed or empty.	Open or replace gas cylinder.
		Gas hose is dirty or obstructed.	Check the tube system for dirt accumulation or obstruction, clean or replace it.
		Controller not adjusted.	Calibrate and adjust controller

No.	Fault description	Possible cause	Required measures
4	CO <sub>2</sub> concentration inside too low. Alarm message "CO <sub>2</sub> range".	Current actual CO <sub>2</sub> value outside the tolerance range. For causes and actions, see no. 3.	Operation temporarily possible. Check the tolerance range settings. With other error messages remove the respective cause.
5	CO <sub>2</sub> concentration inside too high	Controller defective	Contact BINDER service.
		Controller not adjusted.	Calibrate and adjust controller
6	CO <sub>2</sub> concentration inside too high. Alarm message "CO <sub>2</sub> range".	Current actual CO <sub>2</sub> value outside the tolerance range. For causes and actions, see no. 5.	Operation temporarily possible. Check the tolerance range settings. With other error messages remove the respective cause.
7	Actual CO <sub>2</sub> value display shows " _ _ _ _ ". Alarm message "CO <sub>2</sub> sensor defective"	CO <sub>2</sub> sensor defective.	Turn off the chamber. If appropriate, replace sensor (chap. 4.2). Contact BINDER service.
	Actual CO <sub>2</sub> value display shows " _ _ _ _ _ ".	CO <sub>2</sub> sensor not connected,	Turn off the chamber. Connect CO <sub>2</sub> sensor (chap. 4.2.1).
8	Actual value of CO <sub>2</sub> deviates largely compared with a reference method. The pH indicator of the cell medium changes its normal color	CO <sub>2</sub> sensor not adjusted.	Calibrate and adjust CO <sub>2</sub> sensor
		CO <sub>2</sub> sensor system defective.	Transfer the cultures to another incubator and contact BINDER Service.
9	Recovery time (up to 5 vol.-% CO <sub>2</sub> ) after doors were open for 2 minutes is < 2 minutes.	CO <sub>2</sub> sensor system defective.	Contact BINDER service.
10	Recovery time (up to 5 vol.-% CO <sub>2</sub> ) after doors were open for 2 minutes is > 10 minutes.	Obstructed gas supply.	Check gas supply (cylinder, connections, hose system).
		Insufficient CO <sub>2</sub> input pressure.	
		Gas fine filter obstructed.	Contact BINDER service.
11	Unusually high gas consumption.	Door gaskets defective.	Replace door gaskets.
		Gas fine filter not connected correctly	Contact BINDER service.

## 26.4 Humidity

No.	Fault description	Possible cause	Required measures
1	No or too low humidity inside.	Water pan empty.	Fill the water pan with water with distilled, sterile water. The pan must have thorough contact to the bottom of the inner chamber (chap. 4.3).
		Unfavorable ambient conditions.	Increase or decrease humidity via humidity control (chap. 14.1)
2	Condensations inside the chamber..	Water pan filled with water when incubator is not operating	Empty water pan when incubator is not operating.
		Doors not closed.	Close door properly.
		Door gaskets defective.	Replace door gaskets.
3	Condensation on the door.	Chamber placed on very cold floor.	Place the chamber on a BINDER stand to increase the distance to the floor.
		Doors not closed.	Close door properly.
		Door gaskets defective.	Replace door gaskets.
		Door heating defective	Contact BINDER service.
		Unfavorable ambient conditions.	Setting the door heating Offset value (chap. 14.2)

No.	Fault description	Possible cause	Required measures
4	Humidity recovery time too long following door opening.	Frequent and longer door openings.	Contact BINDER service to adapt the heating power for the humidity recovery time (chap. 14.3).

## 26.5 Controller

No.	Fault description	Possible cause	Required measures
1	No chamber function. Dark display.	Main power switch is off.	Turn on the main power switch.
2	Menu functions not available.	Menu functions not available with current authorization level.	Log in with the required higher authorization.
3	No access to controller	Password incorrect.	Contact BINDER service.
4	Acknowledging the alarm does not cancel the alarm state.	Cause of alarm persists.	Remove cause of alarm. If the alarm state continues, contact BINDER service.

## 26.6 Sterilization

No.	Fault description	Possible cause	Required measures
1	Alarm message "Sterilization failed"	Sterilization terminated prematurely after less than 6 hours.	If required, repeat sterilization (chap. 23.3).
2	Information message "CO <sub>2</sub> sensor plugged-in"	Trying to start sterilization cycle while the CO <sub>2</sub> sensor still plugged-in	Turn off the chamber and remove CO <sub>2</sub> sensor (chap. 4.2). Restart sterilization (chap. 23.3.1)
3	Information message "Sterilization". "STE" and "Do not open the door" icons are displayed	Sterilization cycle is running.	Wait at least 6 hours before terminating the sterilization cycle. Do not open the door.
4	Information message "Sterilization success" "STE" icon is displayed.	Sterilization successfully completed.	If necessary, let cool down the chamber. Turn off the chamber, connect the CO <sub>2</sub> sensor and put the chamber back into operation.



Only qualified service personnel authorized by BINDER must perform repair. Repaired chambers must comply with the BINDER quality standards.

## 27. Technical description

### 27.1 Factory calibration and adjustment

This chamber was calibrated and adjusted in the factory. Calibration and adjustment were performed using standardized test instructions, according to the QM DIN EN ISO 9001 system applied by BINDER (certified since December 1996 by TÜV CERT). All test equipment used is subject to the administration of measurement and test equipment that is also a constituent part of the BINDER QM DIN EN ISO 9001 systems. They are controlled and calibrated to a DKD-Standard at regular intervals.

A record of this calibration and adjustment is part of the BINDER test certificate of the chamber.

#### Adjustment in factory:

- **Temperature:** 37 °C / 98.6 °F measured in the center of the usable volume
- **CO<sub>2</sub>:** 0 vol.-% CO<sub>2</sub> (100 vol.-% N<sub>2</sub>) and 5 vol.-% CO<sub>2</sub> (sensor head directly exposed to analyzed test gas)

Suitable reference methods applicable for the user for comparison between reference measuring results and the display readings of the controller(s) are explained in chap. 19.

During factory calibration and adjustment, an electronic temperature measuring and display device is used, which is traceable to an acknowledged standards/calibration institution (DKD or PTB for Germany), bearing a valid calibration certificate.

During factory calibration and adjustment, test gases with an analyzed concentration and with adapted flow quantity serve to calibrate the sensor system for CO<sub>2</sub>. The sensor head is exposed directly to the test gas.

### 27.2 Over current protection

A miniature fuse accessible from the outside protects the device against over current. The miniature fuse is located at the rear of the chamber below the strain relief of the power cord. The fuse holder is equipped with a fuse clip 5mm x 20 mm. Replace the fuse only with a substitute of the same ratings. Refer to the technical data of the respective device type. If the fuse is blown, please inform an electronic engineer or BINDER service.

### 27.3 Definition of usable volume

The usable volume illustrated below is calculated as follows:

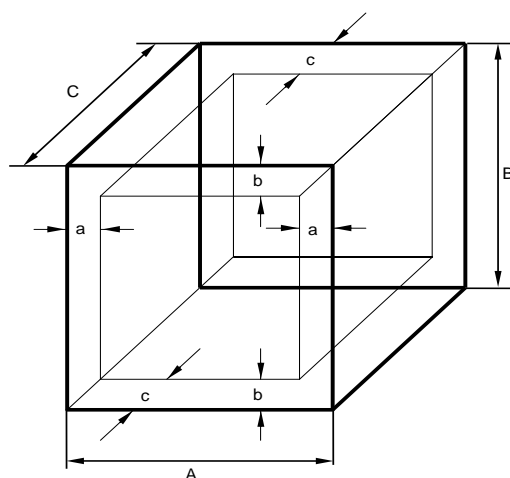

A, B, C = internal dimensions (W, H, D)  
a, b, c = wall separation

$$\begin{aligned} a &= 0.1 \cdot A \\ b &= 0.1 \cdot B \\ c &= 0.1 \cdot C \end{aligned}$$

$$V_{\text{USE}} = (A - 2 \cdot a) \cdot (B - 2 \cdot b) \cdot (C - 2 \cdot c)$$

Figure 24: Determination of the useable volume

The technical data refers to the so defined usable volume.



	<p>Do NOT place samples outside this usable volume.</p> <p>Do NOT load this volume by more than half to enable sufficient airflow inside the CO<sub>2</sub> incubator.</p> <p>Do NOT divide the usable volume into separate parts with large area samples.</p> <p>Do NOT place samples too close to each other in order to permit circulation between them and thus obtain a homogenous distribution of temperature and CO<sub>2</sub>.</p>
---	---

## 27.4 C / C-UL technical data

<b>Exterior dimensions</b>		
Width, net	mm / inch	680 / 26.77
Height including feet	mm / inch	870 / 34.25
Depth, net	mm / inch	715 / 28.15
Depth including door handle, I-triangle, and connections	mm / inch	795 / 31.30
Wall clearance rear (minimum)	mm / inch	100 / 3.94
Wall clearance side (minimum)	mm / inch	50 / 1.97
<b>Doors</b>		
Number of doors		1
Number of inner glass doors		1
<b>Interior dimensions</b>		
Width	mm / inch	560 / 22.05
Height	mm / inch	600 / 23.62
Depth	mm / inch	505 / 19.88
Interior volume	l / cu.ft.	170 / 6.00
<b>Shelves</b>		
Number of shelves, series		3
Number of shelves, max.		8
Size of shelf, width x depth	mm x mm inch x inch	538 x 447 21.18 x 17.60
Maximum load per rack	kg / lbs	10 / 22
Maximum permitted total load	kg / lbs	40 / 88
<b>Weight</b>		
Weight (empty)	kg / lbs	90 / 198
<b>Temperature data</b>		
Temperature range, 6 °C / 10.8 °F above ambient, up to	°C / °F	50 / 122
Temperature fluctuation	≤ +/- K	0.1
Temperature uniformity (variation) at 37 °C / 98.6 °F	+/- K	0.3
Recovery time after door open for 30 sec at 37 °C / 98.6 °F	minutes	8
<b>Humidity data</b>		
Humidity range	% r.h.	90 to 95



<b>CO<sub>2</sub> data</b>		
CO <sub>2</sub> range	vol.-% CO <sub>2</sub>	0 to 20
Setting accuracy	vol.-% CO <sub>2</sub>	0.1
CO <sub>2</sub> fluctuation	vol.-% CO <sub>2</sub>	0.1
Recovery time after door open for 30 sec at 5 vol.-% CO <sub>2</sub>	minutes	5
CO <sub>2</sub> measurement		IR
Connection hose nozzle DN6 for CO <sub>2</sub> Connection to the chamber for hose with internal diameter	mm / inch	6 / 0.24
<b>Electrical data (model version C170-230V)</b>		
IP system of protection acc. to EN 60529	IP	20
Nominal voltage (+/-10%)	at 50 Hz power frequency	V
	at 60 Hz power frequency	V
Current type		1N~
Nominal power	kW	1.30
Power plug (IEC connector plug)		Grounded plug
Installation category acc. to IEC 61010-1		II
Pollution degree acc. to IEC 61010-1		2
Chamber fuse	5x20mm / semi time-lag / 10 A	
<b>Different electrical data for C-UL constructed for the USA and Canada (model version C170UL-120V)</b>		
Nominal voltage (+/-10 %) at 50 Hz power frequency	V	100-120
Nominal voltage (+/-10 %) at 60 Hz power frequency	V	100-120
Power plug (IEC connector plug)	NEMA	5-20P
Chamber fuse	6.3 X 32 mm / 250V / super-time-lag TT / 16A	
<b>Environment-specific data</b>		
Energy consumption at 37 °C / 98.6°F	Wh/h	45
Noise level (mean value)	dB (A)	41

The recovery times of the gas concentrations inside the chamber following the door being opened coincide with a connection pressure of 2.0 bar / 29 psi. Decreasing supply pressure results in longer recovery times.

All technical data is specified for unloaded chambers with standard equipment at an ambient temperature of +22 °C +/- 3 °C / 71.6 °F +/- 5.4 °F and a power supply voltage fluctuation of +/-10%. The technical data is determined in accordance to BINDER Factory Standard Part 2:2015 and DIN 12880:2007.

**All indications are average values, typical for chambers produced in series. We reserve the right to change technical specifications at any time.**

## 27.5 Important conversion data for non-SI units

1 ft = 0.305 m = 0.000305 km

1 m = 100 cm = 3.28 ft = 39.37 inch

1 km = 1000 m = 3280.83 ft

1 mbar = 0.0145 psi

## 27.6 Conversion table for gas inlet pressures, bar – psi

bar	psi	bar	psi	bar	psi
1	14.5	3	43.5	5	72.5
1.5	21.7	3.5	50.7	5.5	79.7
2	29.0	4	58.0	6	87.0
2.5	36.3	4.5	65.2		

## 27.7 Equipment and options (extract)



To operate the chamber, use only original BINDER accessories or accessories / components from third-party suppliers authorized by BINDER. The user is responsible for any risk arising from using unauthorized accessories.

Regular equipment
Microprocessor controller RD4 for temperature and CO <sub>2</sub>
CO <sub>2</sub> infra-red absorption measuring system
Hot-air sterilization at 180 °C / 356°F
Gas mixing head
Ethernet interface for computer communication
USB interface
Weldless deep-drawn inner chamber made of stainless steel V2A (German material no. 1.4301, US equivalent AISI 304), polished
Electronic error auto-diagnosis system with zero-voltage relay alarm output
Safety controller (temperature safety device class 3.1 acc. to DIN 12880:2007)
Tightly closing inner glass door
3 perforated shelves, stainless steel (German material no. 1.4016, US equivalent AISI 430)

Options / accessories
Perforated shelf, stainless steel
Door hinged left (option only available when ordering the chamber, no retrofitting)
Silicone access ports, closable with 2 silicone plugs 30 mm / 1.18 in , rear, left or right side
Analog outputs 4-20mA for temperature and CO <sub>2</sub> , with DIN socket 6-poles, DIN plug included
BINDER Data logger kit T 220
Base on castors
Stacking adapter for direct, thermally decoupled stacking
Gas cylinder connection kit
Pressure reducer
Cleaning kit (neutral cleaning agent, disinfection spray and lint-free disposable wipes, protective gloves and safety goggles)
Calibration of temperature and CO <sub>2</sub> including certificate
Spatial temperature measurement including certificate
Spatial temperature measurement acc. to DIN 12880:2007 including certificate
Qualification folder

## 27.8 Options, accessories, and spare parts (extract)



BINDER GmbH is responsible for the safety features of the chamber only, provided skilled electricians or qualified personnel authorized by BINDER perform all maintenance and repair, and if components relating to chamber safety are replaced in the event of failure with original spare parts. The user is responsible for any risks arising from using unauthorized accessories/components.

Description	Art. no.
Perforated shelf, stainless steel	6004-0142
Base on castors	9051-0029
Stacking adapter for direct, thermally decoupled stacking	9051-0036
Gas cylinder connection kit for CO <sub>2</sub>	8012-0014
Pressure reducer	6013-0016
Calibration certificate for temperature and CO <sub>2</sub>	8012-0228
Cleaning kit (neutral cleaning agent, disinfection spray and lint-free disposable wipes), protective gloves and safety goggles	8012-0503
Neutral cleaning agent, 1 kg	1002-0016
Shelf holder, stainless steel	6004-0145
Door gasket chamber door	6005-0243
Door gasket glass door	6005-0508
Water pan	4022-0325
Chamber fuse 5x20mm 250V 10A semi time-lag (M) (for 230V chambers)	5006-0012
Chamber fuse 6.3 x 32 mm 250V 16A time-lag (T) (for UL chambers)	5006-0033
CO <sub>2</sub> sensor	5002-0066
Filter cap for CO <sub>2</sub> sensor	6014-0033
Gas fine filter	8009-0369
Power cable with IEC connector plug for EU	5023-0222
Power cable with IEC connector plug for Switzerland	8012-0218
Power cable with IEC connector plug for England	8012-0220
Power cable with IEC connector plug for USA	5023-0220

For information on components not listed here, please contact BINDER Service.

Validation service	Art. no.
Qualification folder IQ-OQ	8012-0875
Qualification folder IQ-OQ-PQ	8012-0962
Execution of IQ-OQ	DL410200
Execution of IQ-OQ-PQ	DL440500

Calibration service	Art. no.
Calibration of CO <sub>2</sub> including certificate	DL300401
Calibration of temperature including certificate (1 measuring point)	DL300101
Spatial temperature measurement including certificate (9 measuring points)	DL300109
Spatial temperature measurement including certificate (18 measuring points)	DL300118
Spatial temperature measurement including certificate (27 measuring points)	DL300127

## 27.9 Dimensions C 170

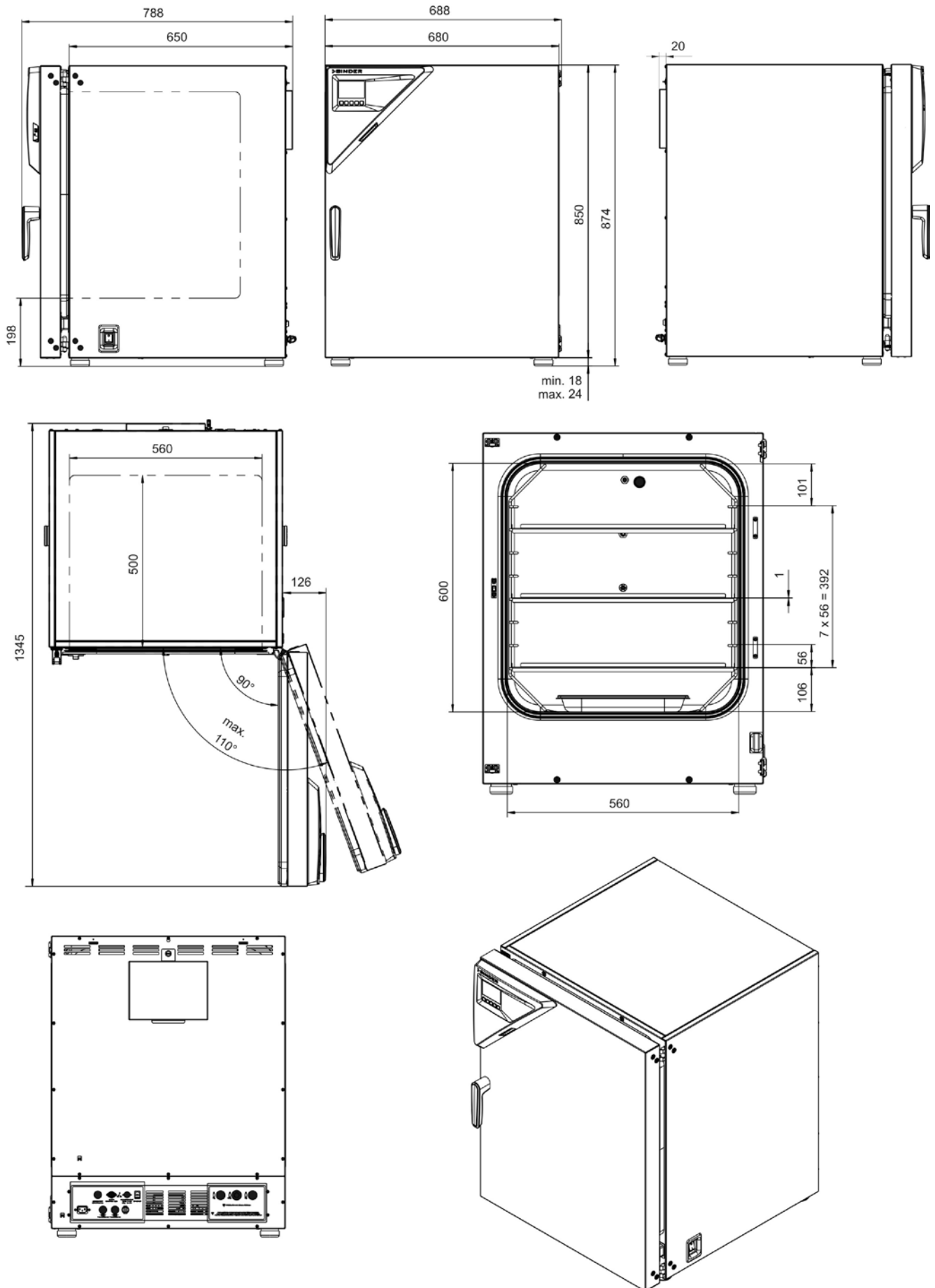

## 28. Certificates and declarations of conformity

### 28.1 EU Declaration of Conformity



Best conditions for your success

	<b>EU-Konformitätserklärung / EU Declaration of Conformity / Déclaration de conformité UE / Declaración de conformidad UE / Dichiarazione di conformità UE / Декларация соответствия EU</b>
Hersteller / Manufacturer / Fabricant / Fabricante / Fabbrikante / Производитель	BINDER GmbH
Anschrift / Address / Adresse / Dirección / Indirizzo / Адрес	Im Mittleren Ösch 5, 78532 Tuttlingen, Germany
Produkt / Product / Produit / Producto / Prodotto / Продукт	CO <sub>2</sub> -Inkubatoren CO <sub>2</sub> Incubators Incubateurs à CO <sub>2</sub> Incubadoras de CO <sub>2</sub> Incubatori a CO <sub>2</sub> CO <sub>2</sub> инкубаторы
Typenbezeichnung / Type / Type / Tipo / Tipo / Тип	C 170 (E7)
Art. No. / Art. no. / Réf. / Art. N° / Art. n. / № арт.	9040-0163, 9140-0163 9040-0164, 9140-0164

Die oben beschriebenen Produkte sind konform mit folgenden EU-Richtlinien:  
 The products described above are in conformity with the following EU Directives:  
 Les produits décrits ci-dessus sont conformes aux directives UE suivantes:  
 Los productos descritos arriba cumplen con las siguientes directivas de la UE:  
 I prodotti sopra descritti sono conformi alle seguenti direttive UE:  
 Продукты, указанные выше, полностью соответствуют следующим EU руководствам:

- **2014/35/EU**  
Niederspannungsrichtlinie 2014/35/EU / Low voltage directive 2014/35/EU / Directive basse tension 2014/35/UE / Directiva sobre baja tensión 2014/35/UE / Direttiva Bassa tensione 2014/35/UE / Директива по низкому напряжению 2014/35/EU
- **2014/30/EU**  
EMV-Richtlinie 2014/30/EU / EMC Directive 2014/30/EU / Directive CEM 2014/30/UE / Directiva CEM 2014/30/UE / Direttiva EMC 2014/30/UE / Директива ЭМС 2014/30/EU
- **2011/65/EU**  
RoHS-Richtlinie 2011/65/EU / RoHS Directive 2011/65/EU / Directive RoHS 2011/65/UE / Directiva RoHS 2011/65/UE / Direttiva RoHS 2011/65/UE / Директива RoHS 2011/65/EU

Die oben beschriebenen Produkte tragen entsprechend die Kennzeichnung CE.  
 The products described above, corresponding to this, bear the CE-mark.  
 Les produits décrits ci-dessus, en correspondance, portent l'indication CE.  
 Los productos descritos arriba, en conformidad, llevan la indicación CE.  
 I prodotti sopra descritti, conformi a quanto sopra, portano il marchio CE.  
 Данные продукты в соответствии с изложенным выше маркированы знаком CE.

1 / 2

**BINDER GmbH** Postfach 102 D-78502 Tuttlingen **Hausanschrift:** BINDER GmbH Im Mittleren Ösch 5 D-78532 Tuttlingen  
**Kontakt:** Telefon: +49 (0) 74 62 / 20 05 - 0 | Telefax: +49 (0) 74 62 / 20 05 - 100 | info@binder-world.com | www.binder-world.com  
**Geschäftsführung:** Dipl.-Ing. Peter M. Binder | Amtsgericht Tuttlingen, HRB 385 Tu. | Sitz der Gesellschaft: Tuttlingen  
**Bankverbindung:** Kreissparkasse Tuttlingen Konto-Nr.: 2266 BLZ: 643 500 70 | IBAN-Code: DE05643 500700 000002266 | SWIFT-Code: SOLA DE 31TUT  
 Deutsche Bank Tuttlingen Konto-Nr.: 2 138 709 BLZ: 653 700 75 | IBAN-Code: DE56653 70075 0213870900 | SWIFT-Code: DEUT DE 3303

Die oben beschriebenen Produkte sind konform mit folgenden harmonisierten Normen:  
The products described above are in conformity with the following harmonized standards:  
Les produits décrits ci-dessus sont conformes aux normes harmonisées suivantes:  
Los productos descritos arriba cumplen con las siguientes normas:  
I prodotti sopra descritti sono conformi alle seguenti normative armonizzate:  
Продукты, указанные выше, полностью соответствуют следующим стандартам:

Sicherheit / Safety / Sécurité / Seguridad / Sicurezza / Нормативы по безопасности
<ul style="list-style-type: none"><li>• EN 61010-1:2010</li><li>• EN 61010-2-010:2014</li></ul>
EMV / EMC / CEM / CEM / EMC / ЭМС
<ul style="list-style-type: none"><li>• EN 61326-1:2013</li></ul>
RoHS
<ul style="list-style-type: none"><li>• EN 50581:2012</li></ul>

78532 Tuttlingen, 17.06.2019  
BINDER GmbH

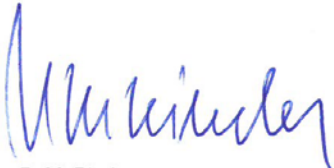

P. M. Binder

Geschäftsführender Gesellschafter  
Managing Director  
Directeur général  
Director general  
Direttore Generale  
Генеральный Директор



J. Bollaender

Leiter F & E  
Director R & D  
Chef de service R&D  
Responsable I & D  
Direttore R & D  
Глава департамента R&D



## 29. Product registration

# Online Product Registration

Register your BINDER now!

[www.binder-world.com/register](http://www.binder-world.com/register)

The registration is free and takes just a few seconds

Advantages:

- ▶ Short response times if service is needed
- ▶ Fair prices when relocating or installing equipment
- ▶ Calibration as required at no charge in case of recalls
- ▶ Free information on news, product upgrades and accessories

Easy registered in 3 steps:



1. List serial number here:

  -      

2. Go online: [www.binder-world.com/register](http://www.binder-world.com/register)

3. Register serial number

## 30. Contamination clearance certificate

Unbedenklichkeitsbescheinigung

### 30.1 For chambers located outside the USA and Canada

#### Declaration regarding safety and health

Erklärung zur Sicherheit und gesundheitlichen Unbedenklichkeit

The German Ordinance on Hazardous Substances (GefStofV), and the regulations regarding safety at the workplace require that this form be filled out for all products that are returned to us, so that the safety and the health of our employees can be guaranteed.

Die Sicherheit und Gesundheit unserer Mitarbeiter, die Gefahrstoffverordnung GefStofV und die Vorschriften zur Sicherheit am Arbeitsplatz machen es erforderlich, dass dieses Formblatt für alle Produkte, die an uns zurückgeschickt wird.

	<p>Note: A repair is not possible without a completely filled out form. Ohne Vorliegen des vollständig ausgefüllten Formblattes ist eine Reparatur nicht möglich.</p>
---	---

- A completely filled out form must be transmitted via Fax (+49 (0) 7462 2005 93555) or by letter in advance, so that this information is available before the equipment/component part arrives. A second copy of this form must accompany the equipment/component part. In addition, the carrier should be notified.

Eine vollständig ausgefüllte Kopie dieses Formblattes soll per Telefax (Nr. +49 (0) 7462 2005 93555) oder Brief vorab an uns gesandt werden, so dass die Information vorliegt, bevor das Gerät/Bauteil eintrifft. Eine weitere Kopie soll dem Gerät/Bauteil beigelegt sein. Ggf. ist auch die Spedition zu informieren.

- Incomplete information or non-conformity with this procedure will inevitably lead to substantial delays in processing. Please understand the reason for this measure, which lies outside our area of influence and will help us to speed up this procedure.

Unvollständige Angaben oder Nichteinhalten dieses Ablaufs führen zwangsläufig zu beträchtlichen Verzögerungen in der Abwicklung. Bitte haben Sie Verständnis für Maßnahmen, die außerhalb unserer Einflussmöglichkeiten liegen und helfen Sie mit, den Ablauf beschleunigen.

- **Please print and fill out this form completely.**

Bitte unbedingt vollständig ausfüllen!

<b>1.</b>	<b>Unit/ component part / type: / Gerät / Bauteil / Typ:</b>
<b>2.</b>	<b>Serial No./ Serien-Nr.:</b>
<b>3.</b>	<b>Details about utilized substances / biological substances / Einzelheiten über die eingesetzten Substanzen/biologische Materialien:</b>
<b>3.1</b>	<b>Designations / Bezeichnungen:</b>
a)	_____
b)	_____
c)	_____
<b>3.2</b>	<b>Safety measures required for handling these substances / Vorsichtsmaßnahmen beim Umgang mit diesen Stoffen:</b>
a)	_____
b)	_____
c)	_____



<b>3.3</b>	<b>Measures to be taken in case of skin contact or release into the atmosphere / Maßnahmen bei Personenkontakt oder Freisetzung:</b> a) _____ b) _____ c) _____ d) _____
<b>3.4</b>	<b>Other important information that must be taken into account / Weitere zu beachtende und wichtige Informationen:</b> a) _____ b) _____ c) _____
<b>4.</b>	<b>Declaration on the risk of these substances (please checkmark the applicable items) / Erklärung zur Gefährlichkeit der Stoffe (bitte Zutreffendes ankreuzen) :</b>
<input type="checkbox"/>	<b>4.1 For non toxic, non radioactive, biologically harmless materials / für nicht giftige, nicht radioaktive, biologisch ungefährliche Stoffe:</b> <b>We hereby guarantee that the above-mentioned unit / component part... / Wir versichern, dass o.g. Gerät/Bauteil...</b> <input type="checkbox"/> Has not been exposed to or contains any toxic or otherwise hazardous substances / weder giftige noch sonstige gefährliche Stoffe enthält oder solche anhaften. <input type="checkbox"/> That eventually generated reaction products are non-toxic and also do not represent a hazard / auch evtl. entstandene Reaktionsprodukte weder giftig sind noch sonst eine Gefährdung darstellen. <input type="checkbox"/> Eventual residues of hazardous substances have been removed / evtl. Rückstände von Gefahrstoffen entfernt wurden.
<input type="checkbox"/>	<b>4.2 For toxic, radioactive, biologically harmful or hazardous substances, or any other hazardous materials / für giftige, radioaktive, biologisch bedenkliche bzw. gefährliche Stoffe oder anderweitig gefährliche Stoffe.</b> <b>We hereby guarantee that ... / Wir versichern, dass ...</b> <input type="checkbox"/> The hazardous substances, which have come into contact with the above-mentioned equipment/component part, have been completely listed under item 3.1 and that all information in this regard is complete / die gefährlichen Stoffe, die mit dem o.g. Gerät/Bauteil in Kontakt kamen, in 3.1 aufgelistet sind und alle Angaben vollständig sind. <input type="checkbox"/> That the unit /component part has not been in contact with radioactivity / das Gerät/Bauteil nicht mit Radioaktivität in Berührung kam
<b>5.</b>	<b>Kind of transport / transporter / Transportweg/Spediteur:</b>  Transport by (means and name of transport company, etc.) / Versendung durch (Name Spediteur o.ä.) _____  Date of dispatch to BINDER GmbH / Tag der Absendung an BINDER GmbH: _____

**We hereby declare that the following measures have been taken / Wir erklären, dass folgende Maßnahmen getroffen wurden:**

- Hazardous substances were removed from the unit including component parts, so that no hazard exists for any person in the handling or repair of these items / das Gerät/Bauteil wurde von Gefahrstoffen befreit, so dass bei Handhabung/Reparaturen für die betreffenden Person keinerlei Gefährdung besteht
- The unit was securely packaged and properly identified / das Gerät wurde sicher verpackt und vollständig gekennzeichnet.
- Information about the hazardousness of the shipment (if required) has been provided to the transporter / der Spediteur wurde (falls vorgeschrieben) über die Gefährlichkeit der Sendung informiert.

We hereby commit ourselves and guarantee that we will indemnify BINDER GmbH for all damages that are a consequence of incomplete or incorrect information provided by us, and that we will exempt BINDER GmbH from eventual damage claims by third parties./ Wir versichern, dass wir gegenüber BINDER für jeden Schaden, der durch unvollständige und unrichtige Angaben entsteht, haften und BINDER gegen eventuell entstehende Schadenansprüche Dritter freistellen.

We are aware that, in accordance with Article 823 of the German Civil Code (BGB), we are directly liable with regard to third parties, in this instance especially the employees of BINDER GmbH, who have been entrusted with the handling / repair of the unit / component. / Es ist uns bekannt, dass wir gegenüber Dritten – hier insbesondere mit der Handhabung/Reparatur des Geräts/des Bauteils betraute Mitarbeiter der Firma BINDER – gemäß §823 BGB direkt haften

Name: \_\_\_\_\_

Position/Title: \_\_\_\_\_

Date / Datum: \_\_\_\_\_

Signature / Unterschrift: \_\_\_\_\_

Company stamp / Firmenstempel:



Equipment that is returned to the factory for repair must be accompanied by a completely filled out contamination clearance certificate. For service and maintenance on site, you must submit such a contamination clearance certificate to the service technician before the start of any work. No repair or maintenance of the equipment is possible, without a properly filled out contamination clearance certificate.

## 30.2 For chambers in the USA and Canada

### Product Return Authorization Request

Please complete this form and the Customer Decontamination Declaration (next 2 pages) and attach the required pictures. E-mail to: IDL\_SalesOrderProcessing\_USA@binder-world.com

After we have received and reviewed the complete information we will decide on the issue of a RMA number. Please be aware that size specifications, voltage specifications as well as performance specifications are available on the internet at [www.binder-world.us](http://www.binder-world.us) at any time.

Take notice of shipping laws and regulations.

	Please fill:	
Reason for return request	<input type="radio"/> Duplicate order	
	<input type="radio"/> Duplicate shipment	
	<input type="radio"/> Demo	<i>Page one completed by sales</i>
	<input type="radio"/> Power Plug / Voltage	115V / 230 V / 208 V / 240V
	<input type="radio"/> Size does not fit space	
	<input type="radio"/> Transport Damage	Shock watch tripped? ( <i>pictures</i> )
	<input type="radio"/> Other (specify below)	
	_____	
Is there a replacement PO?	<input type="radio"/> Yes <input type="radio"/> No	
<i>If yes -&gt; PO #</i>		
<i>If yes -&gt; Date PO placed</i>		
Purchase order number		
BINDER model number		
BINDER serial number		
Date unit was received		
Was the unit unboxed?	<input type="radio"/> Yes <input type="radio"/> No	
Was the unit plugged in?	<input type="radio"/> Yes <input type="radio"/> No	
Was the unit in operation?	<input type="radio"/> Yes <input type="radio"/> No	
<i>Pictures of unit attached?</i>	<input type="radio"/> Yes <input type="radio"/> No	Pictures have to be attached!
<i>Pictures of Packaging attached?</i>	<input type="radio"/> Yes <input type="radio"/> No	

	Customer Contact Information	Distributor Contact Information
Name		
Company		
Address		
Phone		
E-mail		

## Customer (End User) Decontamination Declaration

### Health and Hazard Safety declaration

To protect the health of our employees and the safety at the workplace, we require that this form is completed by the user for all products and parts that are returned to us. (Distributors or Service Organizations cannot sign this form)

	<p>NO RMA number will be issued without a completed form. Products or parts returned to our NY warehouse without a RMA number will be refused at the dock.</p>
---	--

A second copy of the completed form must be attached to the outside of the shipping box.

<b>1.</b>	<b>Unit/ component part / type:</b>
<b>2.</b>	<b>Serial No.</b>
<b>3.</b>	<b>List any exposure to hazardous liquids, gasses or substances and radioactive material</b>
<b>3.1</b>	<b>List with MSDS sheets attached where available or needed (if there is not enough space available below, please attach a page):</b>
a)	_____
b)	_____
c)	_____
<b>3.2</b>	<b>Safety measures required for handling the list under 3.1</b>
a)	_____
b)	_____
c)	_____
<b>3.3</b>	<b>Measures to be taken in case of skin contact or release into the atmosphere:</b>
a)	_____
b)	_____
c)	_____
d)	_____
<b>3.4</b>	<b>Other important information that must be considered:</b>
a)	_____
b)	_____
c)	_____

**4. Declaration of Decontamination**

**For toxic, radioactive, biologically and chemically harmful or hazardous substances, or any other hazardous materials.**

**We hereby guarantee that**

- 4.1 Any hazardous substances, which have come into contact with the above-mentioned equipment / component part, have been completely listed under item 3.1 and that all information in this regard is complete.
- 4.2 That the unit /component part has not been in contact with radioactivity
- 4.3 Any Hazardous substances were removed from the unit / component part, so that no hazard exists for a persons in the shipping, handling or repair of these returned unit
- 4.4 The unit was securely packaged in the original undamaged packaging and properly identified on the outside of the packaging material with the unit designation, the RMA number and a copy of this declaration.
- 4.5 Shipping laws and regulations have not been violated.

**I hereby commit and guarantee that we will indemnify BINDER Inc. for all damages that are a consequence of incomplete or incorrect information provided by us, and that we will indemnify and hold harmless BINDER Inc. from eventual damage claims by third parties..**

Name: \_\_\_\_\_

Position: \_\_\_\_\_

Company: \_\_\_\_\_

Address: \_\_\_\_\_

Phone #: \_\_\_\_\_

Email: \_\_\_\_\_

Date: \_\_\_\_\_

Signature: \_\_\_\_\_



Equipment returned to the NY warehouse for repair must be accompanied by a completed customer decontamination declaration. For service and maintenance works on site, such a customer decontamination declaration must be submitted to the service technician before the start of work. No repair or maintenance of the equipment is possible without a completed form.