

# Instructions For Use

## **TLA-110 Fixed-Angle Rotor**

For Use in the Beckman Coulter  
Optima MAX-XP, MAX-TL, MAX, MAX-E, TL, TLX, and TL-100  
Tabletop Ultracentrifuges



PN TL-TB-019AK  
October 2022



Beckman Coulter, Inc.  
250 S. Kraemer Blvd.  
Brea, CA 92821 U.S.A.



## **TLA-110 Fixed Angle Rotor**

PN TL-TB-019AK (October 2022)

© 2022 Beckman Coulter, Inc.  
All rights reserved.

Beckman Coulter, the stylized logo, and the Beckman Coulter product and service marks mentioned herein are trademarks or registered trademarks of Beckman Coulter, Inc. in the United States and other countries.

All other trademarks are the property of their respective owners.

### **Contact Us**

If you have any questions, contact our Customer Support Center.

- Worldwide, find us via our website at [www.beckman.com/support/technical](http://www.beckman.com/support/technical)
- In the USA and Canada, call us at 1-800-369-0333.
- In Austria, call us at 0810 300484
- In Germany, call us at 02151 333999
- In Sweden, call us at +46 (0)8 564 859 14
- In the Netherlands, call us at +31 348 799 815
- In France, call us at 0825838306 6
- In the UK, call us at +44 845 600 1345
- In Ireland, call us at +353 (01) 4073082
- In Italy, call us at +39 0295392 456
- In other locales, contact your local Beckman Coulter Representative.

Find us on the World Wide Web at: [www.beckman.com](http://www.beckman.com).



Beckman Coulter Eurocenter S.A.  
22, rue Juste-Olivier  
Case Postale 1044  
CH - 1260 Nyon 1, Switzerland  
Tel: +41 (0) 22 365 36 11

Glossary of Symbols is available at  
[beckman.com/techdocs](http://beckman.com/techdocs) (PN C24689).

*May be covered by one or more pat. - see  
[www.beckman.com/patents](http://www.beckman.com/patents)*

Original Instructions

# Revision History

*This document applies to the latest and higher versions. When changes affect the information in this document, a new issue will be released to the Beckman Coulter website. For labeling updates, go to [www.beckman.com/techdocs](http://www.beckman.com/techdocs) and download the most recent manual or system help for your instrument.*

**Issue AH, 5/18**

Changes were made to Table 1, Available Tubes for the TLA-110 Rotor.

**Issue AJ, 6/20**

Changes were made to *Supply List*.

**Issue AK, 10/22**

Changes were made to *Safety Notice, Description*.

**Note:** *Changes that are part of the most recent revision are indicated in text by a bar in the margin of the amended page.*



# Safety Notice

**Read all product manuals and consult with Beckman Coulter-trained personnel before attempting to use this equipment. Do not attempt to perform any procedure before carefully reading all instructions. Always follow product labeling and manufacturer's recommendations. If in doubt as to how to proceed in any situation, contact your Beckman Coulter Representative.**

Beckman Coulter, Inc. urges its customers and employees to comply with all national health and safety standards such as the use of barrier protection. This may include, but is not limited to, protective eyewear, gloves, and suitable laboratory attire when operating or maintaining this or any other laboratory centrifuge.



This safety notice summarizes information basic to the safe use of the rotor described in this manual. The international symbol displayed to the left is a reminder to the user that all safety instructions should be read and understood before operation or maintenance of this equipment is attempted. When you see the symbol on other pages of this publication, pay special attention to the safety information presented. Observance of safety precautions will also help to avoid actions that could damage or adversely affect the performance of the rotor. This rotor was developed, manufactured, and tested for safety and reliability as part of a Beckman Coulter centrifuge/rotor system. Its safety or reliability cannot be assured if used in a centrifuge not of Beckman Coulter's manufacture or in a Beckman Coulter centrifuge that has been modified without Beckman Coulter's approval.

## **WARNING**

**If the equipment is used in a manner not specified by Beckman Coulter, Inc., the protection provided by the equipment may be impaired.**

## **CAUTION**

**If you purchased this product from anyone other than Beckman Coulter or an authorized Beckman Coulter distributor, and, if it is not presently under a Beckman Coulter Service Maintenance Agreement, Beckman Coulter cannot guarantee that the product is fitted with the most current mandatory engineering revisions or that you will receive the most current information bulletins concerning the product. If you purchased this product from a third party and would like further information concerning this topic, [Contact Us](#).**

## Alerts for Warning, Caution, and Note

---

### **WARNING**

**WARNING** indicates a potentially hazardous situation which, if not avoided, could result in death or serious injury.

### **CAUTION**

**CAUTION** indicates a potentially hazardous situation, which, if not avoided, may result in minor or moderate injury. It may also be used to alert against unsafe practices.

**NOTE** NOTE is used to call attention to notable information that should be followed during installation, use, or servicing of this equipment.

## Safety Information for the TLA-110 Rotor

---

**IMPORTANT** This rotor was developed, manufactured, and tested for safety and reliability as part of a Beckman Coulter centrifuge/rotor system. Its safety or reliability cannot be assured if used in a centrifuge not of Beckman Coulter's manufacture or in a Beckman Coulter centrifuge that has been modified without Beckman Coulter's approval.

Handle body fluids with care because they can transmit disease. No known test offers complete assurance that such fluids are free of micro-organisms. Some of the most virulent—Hepatitis (B and C) viruses, HIV (I–V), atypical mycobacteria, and certain systemic fungi—further emphasize the need for aerosol protection. Handle other infectious samples according to good laboratory procedures and methods to prevent spread of disease. Because spills may generate aerosols, observe proper safety precautions for aerosol containment.

Do not run toxic, pathogenic, or radioactive materials in this rotor without taking appropriate safety precautions. Biosafe containment should be used when Risk Group II materials (as identified in the World Health Organization *Laboratory Biosafety Manual*) are handled; materials of a higher group require more than one level of protection.

The rotor and accessories are not designed for use with materials capable of developing flammable or explosive vapors. Do not centrifuge such materials in nor handle or store them near the ultracentrifuge.

Although rotor components and accessories made by other manufacturers may fit in the TLA-110 rotor, their safety in this rotor cannot be ascertained by Beckman Coulter. Use of other manufacturers' components or accessories in the TLA-110 rotor may void the rotor warranty and should be prohibited by your laboratory safety officer. Only the components and accessories listed in this publication should be used in this rotor.

Make sure that filled containers are loaded symmetrically into the rotor and that opposing tubes are filled to the same level with liquid of the same density. Make sure that cavities in use have the proper spacers and/or floating spacers inserted before installing the rotor lid.

If disassembly reveals evidence of leakage, you should assume that some fluid escaped the rotor. Apply appropriate decontamination procedures to the centrifuge and accessories.

Never exceed the maximum rated speed of the rotor and labware in use. Refer to the section on [Run Speeds](#).

Do not use sharp tools on the rotor that could cause scratches in the rotor surface. Corrosion begins in scratches and may open fissures in the rotor with continued use.

## Safety During Installation and/or Maintenance

---

### **WARNING**

**Risk of injury or equipment damage. Vapors from flammable reagents or combustible fluids could enter the centrifuge air system and be ignited by the motor. Do not use the centrifuge in the vicinity of flammable liquids or vapors, and do not run such materials in the instrument.**

### **CAUTION**

**Risk of equipment damage. Corrosion begins in scratches and may open fissures in the rotor, carriers, and carriages with continued use. Do not use sharp tools on the rotor that could cause scratches in the rotor surface carrier and carriage surfaces.**

Perform only the maintenance described in [Maintenance](#).

**IMPORTANT** It is your responsibility to decontaminate components of the instrument before requesting service by a Beckman Coulter Representative or returning parts to Beckman Coulter for repair. Beckman Coulter will NOT accept any items which have not been decontaminated where it is appropriate to do so. If any parts are returned, they must be enclosed in a sealed plastic bag stating that the contents are safe to handle and are not contaminated.

Any servicing of this equipment that requires removal of any covers can expose parts that involve the risk of electric shock or personal injury. Make sure that the power switch is off and the centrifuge is disconnected from the main power source by removing the Mains (power) plug from the outlet receptacle, and refer such servicing to qualified personnel.

Do not replace any centrifuge components with parts not specified for use on this instrument.

### **WARNING**

**Risk of personal injury. Use appropriate lifting techniques when installing this rotor into or removing it from the instrument.**

## Radiation Safety



Use universal precautions when working with radioactive materials. Means must be available to decontaminate the instrument and dispose of radioactive waste.

## Chemical and Biological Safety



Use universal precautions when working with pathogenic materials. Means must be available to decontaminate the instrument and to dispose of biohazardous waste.

**NOTE** Observe all warnings and cautions listed for any external devices attached or used during operation of the instrument. Refer to applicable external device user's manuals for operating procedures of that device.

**NOTE** For Safety Data Sheets (SDS) information, go to the Beckman Coulter website at <https://www.beckman.com/techdocs>.

 **WARNING**

**Risk of chemical injury from bleach. To avoid contact with the bleach, use barrier protection, including protective eyewear, gloves, and suitable laboratory attire. Refer to the Safety Data Sheet for details about chemical exposure before using the chemical.**

 **WARNING**

**Risk of personal injury or equipment damage. Ethanol is a flammability hazard. Do not use it in or near operating or powered centrifuges.**

 **WARNING**

**Risk of personal injury or property damage. The rotors and accessories are not designed for use with materials capable of developing flammable or explosive vapors. Do not centrifuge such materials in, nor handle or store them near the centrifuge.**



 **WARNING**

Risk of personal injury or contamination. Before running the centrifuge with chemical or biological samples, test new labware types to determine if normal operation of the rotor may involve the use of materials that are toxic or otherwise biologically harmful. When using such materials, observe the following precautions:

- Handle infectious samples according to good laboratory procedures and methods to prevent the spread of disease.
- Observe all cautionary information printed on the original solutions' containers prior to their use.
- Dispose of all waste solutions according to your facility's waste disposal procedures.
- Operate the instrument in accordance with the instructions outlined in this manual and take all the necessary precautions when using pathological, toxic, or radioactive materials.
- Splashing of liquids may occur; therefore, take appropriate safety precautions, such as using safety glasses and wearing protective clothing, when working with potentially hazardous liquids.
- Use an appropriately-contained environment when using hazardous materials.
- Observe the appropriate cautionary procedures as defined by your safety officer when using flammable solvents in or near a powered-up instrument.
- Always observe appropriate cautionary procedures as defined by your safety officer when using flammable solvents or toxic, pathological, or radioactive materials.

## Mechanical Safety

---

 **WARNING**

Risk of personal injury. To avoid injury due to moving parts, observe the following:

- Before starting the centrifuge, make sure that the rotor tie-down screw is securely fastened.
- Never attempt to exchange labware or reagents while the instrument is operating.
- Never attempt to physically restrict any of the moving components of the instrument.
- NEVER attempt to slow or stop a rotor by hand.
- Keep the instrument work area clear to prevent obstruction of the movement.

Rotors are designed for use at the speeds indicated; however, speed reductions may be required because of weight considerations of tubes, adapters, and/or the density of the solution being

centrifuged. Be sure to observe the instructions in the applicable rotor manual.

The strength of containers can vary between lots, and will depend on handling and usage. We highly recommend that you pretest them in the rotor (using buffer or gradient of equivalent density to the intended sample solution) to determine optimal operating conditions.

To help prevent premature failures or hazards by detecting stress corrosion, metal fatigue, wear or damage to anodized coatings, and to instruct laboratory personnel in the proper care of rotors, Beckman Coulter offers the Field Rotor Inspection Program (FRIP). This program involves a visit to your laboratory by a specially trained Beckman Coulter representative, who will inspect all of your rotors for corrosion or damage. The representative will recommend repair or replacement of at risk rotors to prevent potential rotor failures. [Contact Us](#) to request this service.

## Cleaning

---

Observe the cleaning procedures outlined in this user's manual for the rotor. Prior to cleaning equipment that has been exposed to hazardous material:

- Contact the appropriate Chemical and Biological Safety personnel.
- Review the Chemical and Biological Safety information in the user's manual.

## Maintenance

---

Perform only the maintenance described in this manual. Maintenance other than that specified in this manual should be performed only by your Beckman Coulter Representative.

**IMPORTANT** It is your responsibility to decontaminate components of the instrument before requesting service by a Beckman Coulter Representative or returning parts to Beckman Coulter. Beckman Coulter will NOT accept any items which have not been decontaminated where it is appropriate to do so. If any parts are returned, they must be enclosed in a sealed plastic bag stating that the contents are safe to handle and are not contaminated.

## Disposal

---

Clean and decontaminate the rotor per the Care and Maintenance section of this manual before disposal. Users are encouraged to check with local waste disposal authorities for specific disposal requirements.

# Contents

## Revision History, iii

## Safety Notice, v

Alerts for Warning, Caution, and Note, vi

Safety Information for the TLA-110 Rotor, vi

Safety During Installation and/or Maintenance, vii

Radiation Safety, viii

Chemical and Biological Safety, viii

Mechanical Safety, ix

Cleaning, x

Maintenance, x

Disposal, x

## TLA-110 Fixed-Angle Rotor, 1

Specifications, 1

Description, 2

Preparation and Use, 3

Prerun Safety Checks, 3

Rotor Preparation, 3

Operation, 5

Removal and Sample Recovery, 6

Tubes and Accessories, 6

Temperature Limits, 7

OptiSeal Tubes, 8

Quick-Seal Tubes, 8

Thickwall Tubes, 8

Microfuge Tubes, 9

Run Times, 9

Run Speeds, 10

Selecting CsCl Gradients, 13

Typical Examples for Determining CsCl Run Parameters, 16

Care and Maintenance, 18

Maintenance, 18

Cleaning, 18

Decontamination, 20

Sterilization and Disinfection, 20

|                             |
|-----------------------------|
| Storage, 20                 |
| Returning a Rotor, 20       |
| Supply List, 21             |
| Replacement Rotor Parts, 21 |
| Other, 22                   |

# Illustrations

- 1 Tube Cap Orientation for Microfuge Tubes, 4
- 2 Arranging Tubes in the Rotor., 4
- 3 Precipitation Curves for the TLA-110 Rotor, 14
- 4 CsCl Gradients at Equilibrium for the TLA-110 Rotor, 15

# Tables

- 1 Available Tubes for the TLA-110 Rotor, 7
- 2 Relative Centrifugal Fields for the TLA-110 Rotor when Using g-Max 3.5-mL Quick-Seal Tubes, 11
- 3 Relative Centrifugal Fields for the TLA-110 Rotor when Using 5.1-mL Quick-Seal Tubes, 12

# TLA-110 Fixed-Angle Rotor

## Specifications

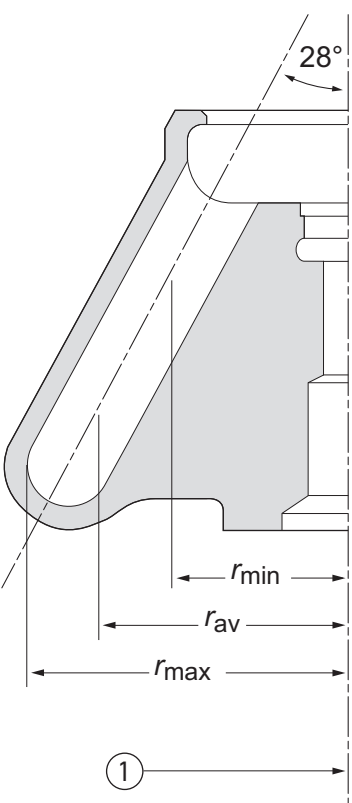
|   |   |                                |
|---|---|--------------------------------|
|  <p>1. Axis of Rotation</p> | Maximum speed   | 110,000 RPM                    |
|   | Density rating at maximum speed                                 | 1.7 g/mL                       |
|   | Relative Centrifugal Field <sup>a</sup> at maximum speed        |                                |
|   | at $r_{\max}$ (48.5 mm)   | $657,000 \times g$             |
|   | at $r_{\text{av}}$ (37.2 mm)                                    | $504,000 \times g$             |
|   | at $r_{\min}$ (26.0 mm)   | $353,000 \times g$             |
|   | $k$ factor at maximum speed                                     | 13                             |
|   | Conditions requiring speed reductions                           | see <a href="#">Run Speeds</a> |
|   | Number of tube cavities   | 8                              |
|   | Available tubes   | see <a href="#">Table 1</a>    |
|   | Nominal tube dimensions (largest tube)                          | 13 × 51 mm                     |
|   | Nominal tube capacity   | 5.1 mL                         |
|   | Nominal rotor capacity  | 40.8 mL                        |
|   | Approximate acceleration time to maximum speed (fully loaded)   | 4 min                          |
|   | Approximate deceleration time from maximum speed (fully loaded) | 2 min                          |
|   | Weight of fully loaded rotor                                    | 1.0 kg (2.2 lb)                |
| Rotor material  | titanium  |                                |

- a. Relative Centrifugal Field (RCF) is the ratio of the centrifugal acceleration at a specified radius and speed ( $r\omega^2$ ) to the standard acceleration of gravity ( $g$ ) according to the following formula:  $\text{RCF} = r\omega^2/g$  — where  $r$  is the radius in millimeters,  $\omega$  is the angular velocity in radians per second ( $2\pi \text{ RPM}/60$ ), and  $g$  is the standard acceleration of gravity ( $9807 \text{ mm/s}^2$ ). After substitution:  $\text{RCF} = 1.12r (\text{RPM}/1000)^2$

## Description

---

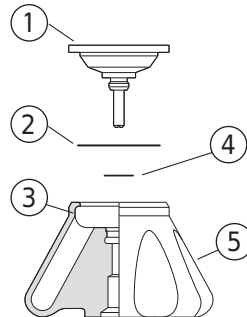

1. Lid Assembly (366732)
2. Lid O-ring (outer) (854519)
3. Fluid-Containment Annulus
4. Lid O-ring (inner) (824412)
5. Rotor Body (366733)

Beckman Coulter TLA-110 rotors are manufactured in a facility that maintains certifications to both ISO 9001:2008 and ISO 13485:2003. They are for use with the specified Beckman Coulter centrifuges.

The TLA-110 fixed-angle rotor has a tube angle of 28 degrees from the axis of rotation. The rotor can centrifuge up to eight tubes.

The rotor is made of titanium and is finished with black polyurethane paint. The lid is made of aluminum and anodized to resist corrosion. A plunger in the lid locks the rotor to the drive hub before beginning the run, and two lubricated O-rings made of Buna-N rubber maintain atmospheric pressure inside the rotor during centrifugation. The tube cavities are numbered to aid in sample identification.

The rotor is specially designed with a fluid-containment annulus located below the O-ring sealing surface. The annulus retains fluid that may escape from leaking or overfilled tubes, thereby preventing the liquid from escaping into the instrument chamber.

The ultracentrifuge identifies rotor speed during the run by means of a magnetic speed sensor in the instrument chamber and magnets on the bottom of the rotor. This overspeed protection system ensures that the rotor does not exceed its maximum permitted speed.

Refer to the Warranty at the back of this manual for warranty information.



## Preparation and Use

---

*Specific information about the TLA-110 rotor is given here. Information common to this and other rotors is contained in *Rotors and Tubes for Tabletop Preparative Ultracentrifuges* (publication TLR-IM), which should be used together with this manual for complete rotor and accessory operation. Publication TLR-IM is included in the literature package shipped with the rotor.*

**NOTE** Although rotor components and accessories made by other manufacturers may fit in the TLA-110 rotor, their safety in this rotor cannot be ascertained by Beckman Coulter. Use of other manufacturers' components or accessories in the TLA-110 rotor may void the rotor warranty and should be prohibited by your laboratory safety officer. Only the components and accessories listed in this publication should be used in this rotor.

### Prerun Safety Checks

*Read the [Safety Notice](#) section at the front of this manual before using the rotor.*

- 
- 1 Inspect the O-rings and plunger mechanism for damage—the high forces generated in this rotor can cause damaged components to fail.

---

  - 2 Use only tubes and accessories listed in [Table 1](#).

---

  - 3 Check the chemical compatibilities of all materials used (refer to *Chemical Resistances*, publication IN-175).
- 

### Rotor Preparation

*For runs at other than room temperature, refrigerate or warm the rotor beforehand for fast equilibration.*

- 
- 1 Lightly but evenly lubricate metal threads with Spinkote lubricant (306812).

---

  - 2 Apply a thin film of silicone vacuum grease (335148) to the two O-rings in the rotor lid.

- 3 If using 1.5 mL Microfuge tubes, place the adapters into the tube cavities before inserting the tubes.
  - a. Cut the hinges off the caps.
  - b. Face the lift tab of all tubes toward the outside of the rotor (see [Figure 1](#)) before installing the rotor lid.

**Figure 1** Tube Cap Orientation for Microfuge Tubes

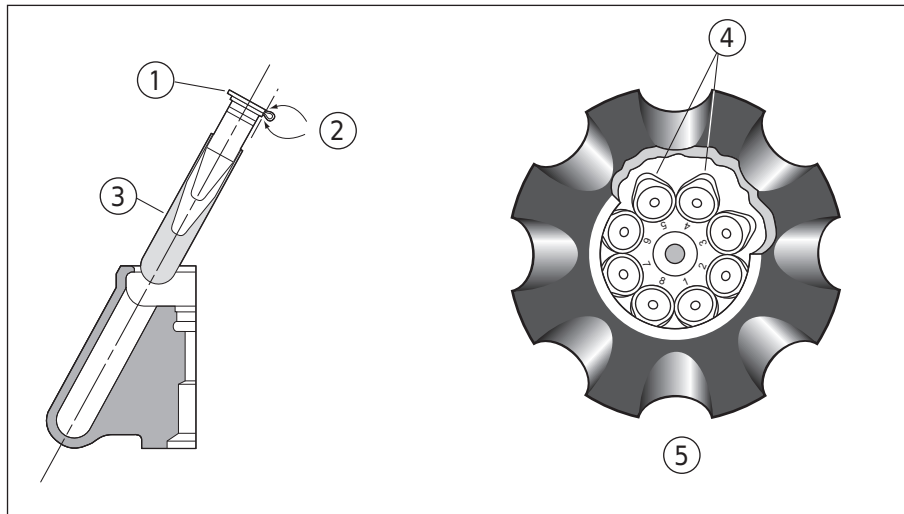

1. Face tab toward outer edge of rotor
2. Cut hinge off before inserting tube
3. Adapter
4. Lift tab should face out
5. Top View of Rotor

- 4 Load the filled and capped tubes symmetrically into the rotor (see page 6 for tube information). If fewer than eight tubes are being run, they must be arranged symmetrically in the rotor (see [Figure 2](#)).

*Opposing tubes must be filled to the same level with liquid of the same density.*

**Figure 2** Arranging Tubes in the Rotor.

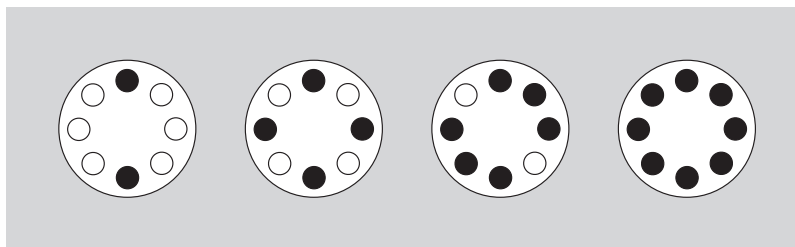

**NOTE** Two, four, six, or eight tubes can be centrifuged per run if they are arranged in the rotor as shown.

- 5 Use the required spacers, if necessary (see [Table 1](#)), to complete the loading operation.
- 6 After the rotor is loaded, insert it into the portable polypropylene rotor vise (346133). Place the lid on the rotor and tighten it firmly to the right (clockwise) by hand. No tool is required.

## Operation

- 1 Use an absorbent towel to wipe off condensation from the rotor, then carefully place the rotor on the drive hub.
- 2 Lock the rotor in place by gently pressing the plunger down until you feel it click. When you remove your finger, the plunger will remain flush with the rotor body if it is properly engaged.

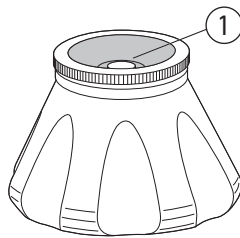

1. Plunger Engaged

If the plunger pops up, repeat the procedure.

The Optima MAX-TL, MAX-XP, MAX, and MAX-E ultracentrifuges automatically secure the rotor to the drive shaft without the need for engaging the plunger.

### CAUTION

**In all ultracentrifuge models except the Optima MAX-TL, MAX-XP, MAX, and MAX-E, it is very important to lock the rotor in place before beginning the run to ensure that the rotor remains seated during centrifugation. Failure to lock the rotor in place before beginning the run may result in damage to both rotor and instrument.**

- 3 Refer to the instrument instruction manual for ultracentrifuge operation.

- 
- 4 For additional operating information, see the following:
- [Run Times](#), page 9, for using  $k$  factors to adjust run durations.
  - [Run Speeds](#), page 10, for information about speed limitations.
  - [Selecting CsCl Gradients](#), page 13, for methods to avoid CsCl precipitation during centrifugation.
- 

## Removal and Sample Recovery



If disassembly reveals evidence of leakage, you should assume that some fluid escaped the rotor. Apply appropriate decontamination procedures to the centrifuge and accessories.

- 
- 1 To release the plunger at the end of the run, gently press it down until you feel it click. When you remove your finger the plunger will pop up to its released position.

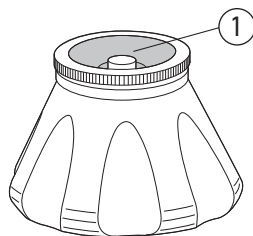

1. Plunger Released

- 
- 2 Remove the rotor from the ultracentrifuge and place it in the rotor vise.
- 
- 3 Remove the lid by unscrewing it to the left (counterclockwise).
- 
- 4 Use a tube removal tool to remove the spacers and tubes.
- 

## Tubes and Accessories

The TLA-110 rotor uses tubes and accessories listed in [Table 1](#). Be sure to use only those items listed, and to observe the maximum speed limits shown. Refer to *Chemical Resistances* (publication IN-175) for information on the chemical compatibilities of tube and accessory materials.



## Temperature Limits

- Plastic tubes have been centrifuge tested for use at temperatures between 2 and 25°C. For centrifugation at other temperatures, pretest tubes under anticipated run conditions.
- If plastic containers are frozen before use, make sure that they are thawed to at least 2°C prior to centrifugation.

**Table 1** Available Tubes for the TLA-110 Rotor<sup>a</sup>

| Tube                              |                                    |                                     | Required Accessory                        |                   | Max. Speed/<br>RCF/<br>k Factor               |
|-----------------------------------|------------------------------------|-------------------------------------|---|-------------------|---|
| Dimensions and Volume             | Description                        | Part Number                         | Description                               | Part Number       |   |
| 13 × 51 mm<br>5.1 mL              | Quick-Seal polypropylene, bell top | 343776<br>(pkg/100)                 | Polyphenylene oxide (PPO) floating spacer | 362307<br>(pkg/8) | 110,000 RPM<br>627,000 × g<br>13              |
| 13 × 48 mm<br>4.7 mL              | OptiSeal <sup>b</sup> bell-top     | 361621<br>(pkg/56)                  | Polyetherimide (PEI) spacer               | 361676<br>(pkg/2) | 110,000 RPM<br>657,000 × g<br>12              |
| 13 × 32 mm<br>3.5 mL              | Quick-Seal polypropylene, bell-top | 349621<br>(pkg/50)                  | Polyphenylene oxide (PPO) floating spacer | 360270<br>(pkg/8) | 110,000 RPM<br>657,000 × g<br>7               |
| 13 × 56 mm<br>3.2 mL <sup>c</sup> | thickwall polycarbonate            | 362305<br>(pkg/50)                  | none                                      | —                 | 110,000 RPM<br>657,000 × g<br>15              |
| 13 × 56 mm<br>3.2 mL              | thickwall polypropylene            | 362333<br>(pkg/50)                  | none                                      | —                 | 70,000 RPM<br>266,000 × g<br>37               |
| 13 × 25 mm<br>2.0 mL              | Quick-Seal polypropylene, bell-top | 345829<br>(pkg/50)                  | Polyphenylene oxide (PPO) floating spacer | 360270<br>(pkg/8) | 110,000 RPM<br>657,000 × g<br>5               |
| 11 × 39 mm<br>1.5 mL              | Microfuge, polypropylene (capped)  | 357448<br>(pkg/500)                 | Polyphenylene oxide (PPO) adapter         | 360951<br>(pkg/8) | 70,000 RPM <sup>de</sup><br>206,000 × g<br>19 |
| 11 × 47 mm<br>1.5 mL              | Microfuge, polypropylene (capped)  | Labcon<br>3611-870-000<br>(pkg/500) | Acetal (POM) adapter                      | 393238<br>(pkg/8) | 110,000 RPM<br>536,000 × g<br>9               |

- Use only the items listed here and observe maximum fill volumes and speeds shown.
- Includes disposable plastic plugs.
- Minimum fill level for this tube is 1.6 mL.
- At 40°C, speed must be reduced to 59,000 RPM.
- Maximum time is 15 minutes at full rated speed.

## OptiSeal Tubes

OptiSeal tubes come with plastic plugs and can be quickly and easily prepared for use. With the tube spacer in place, the  $g$  force during centrifugation ensures a tight, reliable seal that protects your samples.

- 1 Place the tubes in the rack and fill each tube to the base of the stem, leaving no fluid in the stem. Overfilling the tube can cause spillage when the plug is inserted or can compromise seal integrity.

However, too much air can cause excessive tube deformation, disrupting gradients and sample bands.

Refer to *Using OptiSeal Tubes* (publication IN-189), included in each box of tubes, for detailed information on the use and care of OptiSeal tubes.

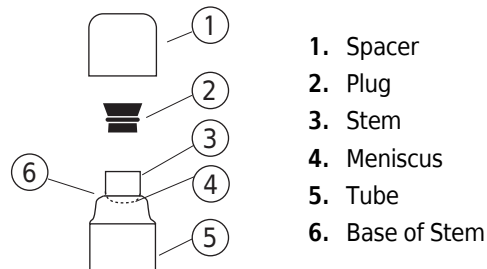

## Quick-Seal Tubes

Quick-Seal tubes must be sealed prior to centrifugation. These tubes are heat sealed and do not need caps; however, spacers are required on top of the tubes when they are loaded into the rotor.

- 1 Fill Quick-Seal tubes leaving a *small* bubble of air at the base of the neck. Do not leave a large air space—too much air can cause excessive tube deformation. Refer to *Rotors and Tubes* for detailed information on the use and care of Quick-Seal tubes.

*g*-Max  
Spacer



Some of the tubes listed in [Table 1](#) are part of the *g*-Max system. The *g*-Max system uses a combination of small bell-top Quick-Seal tubes and floating spacers (also called *g*-Max spacers). This means that you can run the shorter tubes listed in the table in the TLA-110 rotor without reduction in  $g$  force. Additional information about the *g*-Max system is available in publication DS-709B.

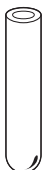

## Thickwall Tubes

Thickwall polypropylene and polycarbonate tubes can be run partially filled (at least half filled) without caps, but all opposing tubes for a run must be filled to the same level with liquid of the same density. Do not overfill capless tubes; be sure to note the reduction in run speed shown in [Table 1](#).

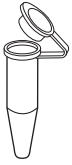

## Microfuge Tubes

The 1.5-mL microfuge tubes, with attached caps, are made of clear polypropylene. The tubes are placed in adapters for use in this rotor. All opposing tubes for a run must be filled with liquid of the same density. Be sure to note the run speed reduction shown in [Table 1](#).

## Run Times

The  $k$  factor of the rotor is a measure of the rotor's pelleting efficiency. Beckman Coulter has calculated the  $k$  factors for all of its preparative rotors at maximum rated speed and using full tubes. The  $k$  factor is calculated from the formula:

EQ 1

$$k = \frac{\ln(r_{\max}/r_{\min})}{\omega^2} \times \frac{10^{13}}{3600}$$

where  $\omega$  is the angular velocity of the rotor in radians per second ( $\omega = 0.105 \times \text{RPM}$ ),  $r_{\max}$  is the maximum radius, and  $r_{\min}$  is the minimum radius.

After substitution:

EQ 2

$$k = \frac{(2.533 \times 10^{11}) \ln(r_{\max}/r_{\min})}{(\text{RPM})^2}$$

Use the  $k$  factor in the following equation to estimate the run time  $t$  (in hours) required to pellet particles of known sedimentation coefficient  $s$  (in Svedberg units, S).

EQ 3

$$t = \frac{k}{s}$$

Run times can be estimated for centrifugation at less than maximum speed by adjusting the  $k$  factor as follows:

EQ 4

$$k_{\text{adj}} = k \left( \frac{110,000}{\text{actual run speed}} \right)^2$$

Run times can also be estimated from data established in prior experiments if the  $k$  factor of the previous rotor is known. For any two rotors, a and b:

EQ 5

$$\frac{t_a}{t_b} = \frac{k_a}{k_b}$$

For more information on  $k$  factors see *Use of  $k$  Factor for Estimating Run Times from Previously Established Run Conditions* (publication DS-719).

## Run Speeds

The centrifugal force at a given radius in a rotor is a function of speed. Comparisons of forces between different rotors are made by comparing the rotors' relative centrifugal fields (RCF). When rotational speed is adjusted so that identical samples are subjected to the same RCF in two different rotors, the samples are subjected to the same force. The RCF at a number of rotor speeds is provided in [Table 2](#) and [Table 3](#).



**Table 2** Relative Centrifugal Fields for the TLA-110 Rotor when Using *g*-Max 3.5-mL Quick-Seal Tubes<sup>a</sup>

| Rotor Speed (RPM) | Relative Centrifugal Field ( $\times g$ ) |                              |                         | <i>k</i> Factor* |
|-------------------|---|------------------------------|-------------------------|------------------|
|                   | At $r_{\max}$ (48.5 mm)                   | At $r_{\text{av}}$ (37.2 mm) | At $r_{\min}$ (26.0 mm) |                  |
| 110,000           | 675,000                                   | 504,000                      | 353,000                 | 13               |
| 105,000           | 599,000                                   | 459,000                      | 321,000                 | 14               |
| 100,000           | 543,000                                   | 417,000                      | 291,000                 | 16               |
| 95,000            | 490,000                                   | 376,000                      | 263,000                 | 17               |
| 90,000            | 440,000                                   | 338,000                      | 236,000                 | 19               |
| 85,000            | 393,000                                   | 301,000                      | 210,000                 | 22               |
| 80,000            | 348,000                                   | 267,000                      | 186,000                 | 25               |
| 75,000            | 306,000                                   | 234,000                      | 164,000                 | 28               |
| 70,000            | 266,000                                   | 204,000                      | 143,000                 | 32               |
| 65,000            | 230,000                                   | 176,000                      | 123,000                 | 37               |
| 60,000            | 196,000                                   | 150,000                      | 105,000                 | 44               |
| 55,000            | 164,000                                   | 126,000                      | 88,100                  | 52               |
| 50,000            | 136,000                                   | 104,000                      | 72,800                  | 63               |
| 45,000            | 110,000                                   | 84,400                       | 59,000                  | 78               |
| 40,000            | 86,900                                    | 66,700                       | 46,600                  | 99               |
| 35,000            | 66,600                                    | 51,000                       | 35,700                  | 129              |
| 30,000            | 48,900                                    | 37,500                       | 26,200                  | 175              |
| 25,000            | 34,000                                    | 26,000                       | 18,200                  | 253              |
| 20,000            | 21,700                                    | 16,700                       | 11,700                  | 395              |

a. Entries in this table are calculated from the formula  $RCF = 1.12r(RPM/1000)^2$  and then rounded to three significant digits.

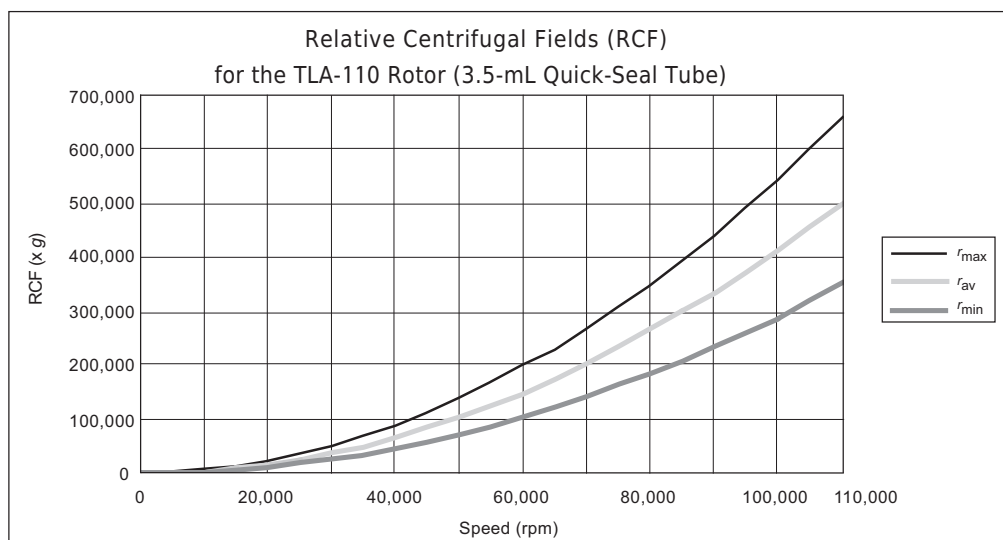

**Table 3** Relative Centrifugal Fields for the TLA-110 Rotor when Using 5.1-mL Quick-Seal Tubes<sup>a</sup>

| Rotor Speed (RPM) | Relative Centrifugal Field ( $\times g$ ) |                              |                         | k Factor* |
|-------------------|---|------------------------------|-------------------------|-----------|
|                   | At $r_{\max}$ (48.6 mm)                   | At $r_{\text{av}}$ (33.6 mm) | At $r_{\min}$ (18.4 mm) |           |
| 110,000           | 658,000                                   | 455,000                      | 249,000                 | 20        |
| 105,000           | 600,000                                   | 414,000                      | 227,000                 | 22        |
| 100,000           | 544,000                                   | 376,000                      | 206,000                 | 25        |
| 95,000            | 491,000                                   | 339,000                      | 186,000                 | 27        |
| 90,000            | 441,000                                   | 304,000                      | 167,000                 | 30        |
| 85,000            | 393,000                                   | 272,000                      | 149,000                 | 34        |
| 80,000            | 348,000                                   | 241,000                      | 132,000                 | 38        |
| 75,000            | 306,000                                   | 212,000                      | 116,000                 | 44        |
| 70,000            | 267,000                                   | 184,000                      | 101,000                 | 50        |
| 65,000            | 230,000                                   | 159,000                      | 87,100                  | 58        |
| 60,000            | 196,000                                   | 135,000                      | 74,200                  | 68        |
| 55,000            | 165,000                                   | 114,000                      | 62,300                  | 81        |
| 50,000            | 136,000                                   | 93,900                       | 51,500                  | 98        |
| 45,000            | 110,000                                   | 76,100                       | 41,700                  | 121       |
| 40,000            | 87,100                                    | 60,100                       | 33,000                  | 154       |
| 35,000            | 67,000                                    | 46,000                       | 25,300                  | 201       |
| 30,000            | 49,000                                    | 33,100                       | 18,600                  | 273       |
| 25,000            | 34,000                                    | 23,500                       | 12,900                  | 394       |
| 20,000            | 21,800                                    | 15,000                       | 8,240                   | 615       |

a. Entries in this table are calculated from the formula  $RCF = 1.12r (RPM/1000)^2$  and then rounded to three significant digits.

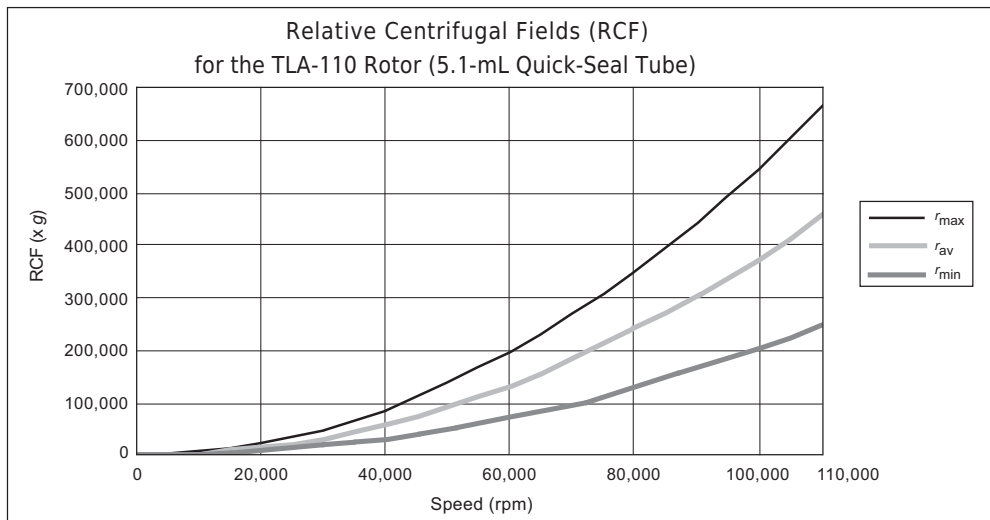

Speeds must be reduced under the following circumstances:

1. If nonprecipitating solutions more dense than 1.7 g/mL are centrifuged, the maximum allowable run speed must be reduced according to the following equation:

EQ 6

$$\text{reduced maximum speed} = (110,000 \text{ RPM}) \sqrt{\frac{1.7 \text{ g/mL}}{\rho}}$$

where  $\rho$  is the density of the tube contents. This speed reduction will protect the rotor from excessive stresses due to the added tube load. *Note, however, that the use of this formula may still produce maximum speed values that are higher than the limitations imposed by the use of certain tubes or adapters.* In such cases, use the lower of the two values.

2. *Further speed limits must be imposed* when CsCl or other self-forming-gradient salts are centrifuged, as equation (6) does not predict concentration limits/speeds that are required to avoid precipitation of salt crystals. Precipitation during centrifugation would alter the density distribution of CsCl and this would change the position of the sample bands. [Figure 3](#) and [Figure 4](#), together with the description and examples below, show how to reduce run speeds when using CsCl gradients.

## Selecting CsCl Gradients

---

Precipitation during centrifugation would alter density distribution, and this would change the position of the sample bands. Curves in [Figure 3](#) and [Figure 4](#) are provided up to the maximum rated speed of the rotor.

**NOTE** The curves in [Figure 3](#) and [Figure 4](#) are for solutions of CsCl salt dissolved in distilled water only. If other salts are present in significant concentrations, the overall CsCl concentration may need to be reduced.

Rotor speed is used to control the slope of a CsCl density gradient, and must be limited so that CsCl precipitation is avoided. Speed and density combinations that intersect on or below the curves in [Figure 3](#) ensure that CsCl will not precipitate during centrifugation in the TLA-110 rotor. Curves are provided at two temperatures: 20°C (black curves) and 4°C (gray curves).

The reference curves in [Figure 4](#) show gradient distribution at equilibrium. Each curve in [Figure 4](#) is within the density limits allowed for the TLA-110 rotor: each curve was generated for a single run speed using the maximum allowable homogeneous CsCl densities (one for each fill level) that avoid precipitation at that speed. (The gradients in [Figure 4](#) can be generated from step or linear gradients, or from homogeneous solutions. But the total amount of CsCl in solution must be equivalent to a homogeneous solution corresponding to the concentrations specified in [Figure 3](#).) [Figure 4](#) can also be used to approximate the banding positions of sample particles.

**Figure 3** Precipitation Curves for the TLA-110 Rotor\*

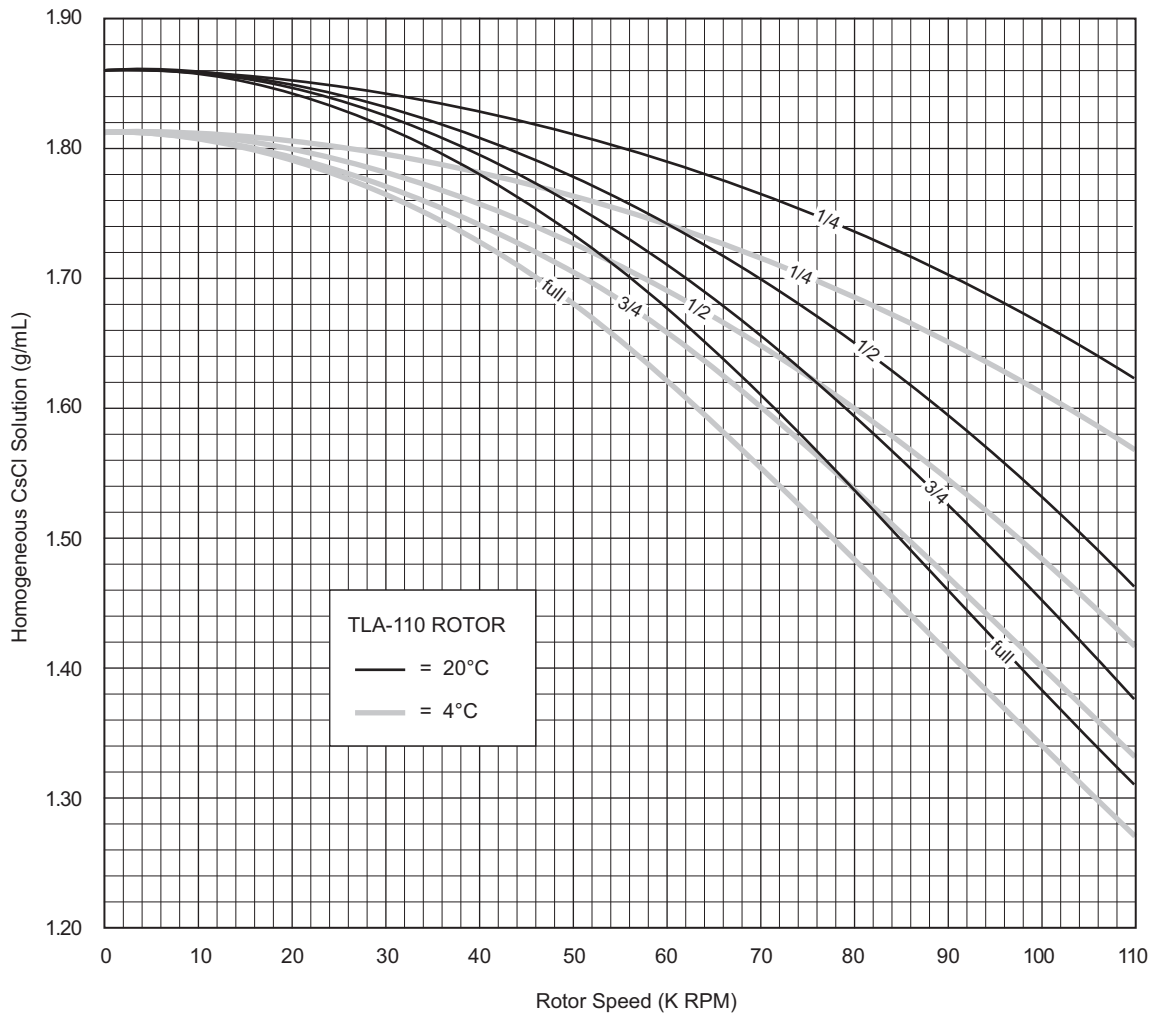

\* Using combinations of rotor speeds and homogeneous CsCl solution densities that intersect on or below these curves ensures that CsCl will not precipitate during centrifugation.

**Figure 4** CsCl Gradients at Equilibrium for the TLA-110 Rotor\*

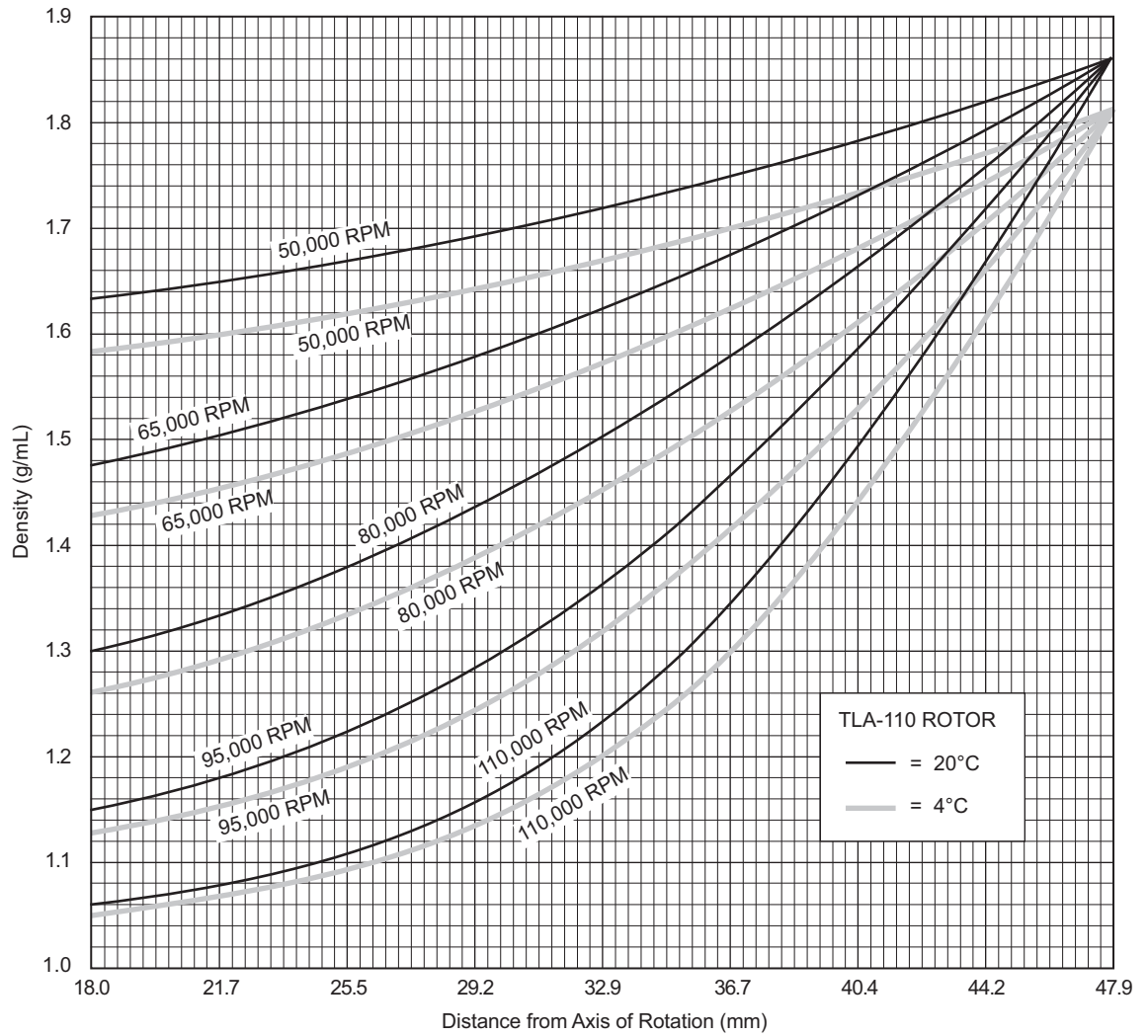

\* Centrifugation of homogeneous CsCl solutions at the maximum allowable speeds (from Figure 3) results in gradients presented here. The homogeneous CsCl solution density used to generate each curve is printed along the curve.

## Typical Examples for Determining CsCl Run Parameters

### Example A:

A separation that is done frequently is the banding of plasmic DNA in cesium chloride with ethidium bromide. The starting density of the CsCl solution is 1.55 g/mL. In this separation the covalently closed, circular plasmid bands at a density of 1.57 g/mL, while the nicked and linear species band at 1.53 g/mL. At 20°C, where will particles band?

- 1 In [Figure 3](#), find the curve that corresponds to the desired run temperature (20°C) and fill volume (three-quarters full).  
The maximum allowable rotor speed is determined from the point where this curve intersects the homogeneous CsCl density (86,000 RPM).
- 2 In [Figure 4](#), sketch in a horizontal line corresponding to each particle's buoyant density.
- 3 Mark the point in the figure where each particle density intersects the curve corresponding to the selected run speed and temperature.
- 4 Particles will band at these locations across the tube diameter at equilibrium during centrifugation.

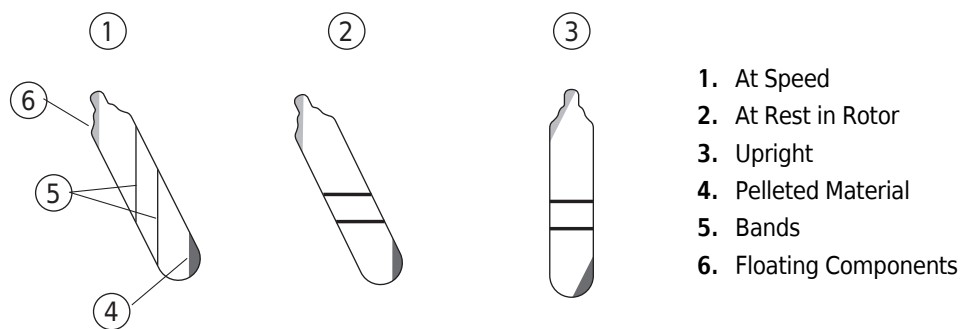

In this example, particles will band about 36 and 38 mm from the axis of rotation, about 2 mm of centerband-to-centerband separation at the rotor's 28-degree tube angle. When the tube is removed from the rotor and held upright (vertical and stationary), there will be about 2.27 mm of

centerband-to-centerband separation. This interband distance,  $d_{up}$ , can be calculated from the formula:

EQ 7

$$d_{up} = \frac{d_{\theta}}{\cos \theta}$$

where  $d_{\theta}$  is the interband distance when the tube is held at an angle,  $\theta$ , in the rotor.

**Example B:**

Knowing particle buoyant densities (e.g., 1.59 and 1.54 g/mL), how do you achieve good separation?

- 
- 1 In [Figure 4](#), sketch in a horizontal line corresponding to each particle's buoyant density.

---

  - 2 Select the curve at the desired temperature (4°C) and fill volume (full) that gives the best particle separation.

---

  - 3 Note the run speed along the selected curve (65,000 RPM).

---

  - 4 From [Figure 3](#), select the maximum homogeneous CsCl density (in this case, 1.59 g/mL) that corresponds to the temperature and run speed established above.  
 These parameters will provide the particle-banding pattern selected in Step 2.

---

In this example, particles will band at about 31 and 34 mm from the axis of rotation (about 3 mm apart). When the tube is held upright there will be about 3.4 mm of center-of-band to center-of-band separation.

## Care and Maintenance

---

### Maintenance

**NOTE** Do not use sharp tools on the rotor that could cause scratches in the rotor surface. Corrosion begins in scratches and may open fissures in the rotor with continued use.

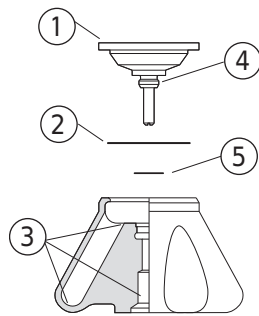

1. Lid Assembly (366732)
2. Lid O-ring (outer) (854519)
3. Check for Corrosion
4. Threads
5. Lid O-ring (inner) (824412)

- 
- 1** Regularly lubricate the metal threads in the rotor plugs with a thin, even coat of Spinkote lubricant.  
Failure to keep these threads lubricated can result in damaged threads.
  - 2** Regularly apply silicone vacuum grease to the O-rings.  
Replace O-rings about twice a year or whenever worn or damaged.
- 

Refer to *Chemical Resistances* (publication IN-175) for the chemical compatibilities of rotor and accessory materials. Your Beckman Coulter representative provides contact with the Field Rotor Inspection Program and the rotor repair center.

### Cleaning

*Wash the rotor and rotor components immediately if salts or other corrosive materials are used or if spillage has occurred. Do not allow corrosive materials to dry on the rotor.*

Under normal use, wash the rotor frequently (at least weekly) to prevent buildup of residues.

- 
- 1** Remove the O-rings before washing.
  - 2** Wash the rotor and lid in a mild detergent, such as Solution 555 (339555), that won't damage the rotor.  
Dilute the detergent with water (10 parts water to 1 part detergent).
-



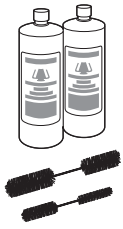

The Rotor Cleaning Kit contains two plastic-coated brushes and two quarts of Solution 555 for use with rotors and accessories.

**NOTE** Do not wash rotor components in a dishwasher. Do not soak in detergent solution for long periods, such as overnight.

- 
- 3** Rinse the cleaned rotor and components with distilled water.

---

  - 4** Air-dry the rotor and lid upside down.  
Do not use acetone to dry the rotor.

---

  - 5** Apply a thin, even coat of silicone vacuum grease to both lid O-rings before replacing them in the grooves in the lid.

---

  - 6** Clean metal threads as necessary (at least every 6 months).
    - a.** Use a brush and concentrated Solution 555.
    - b.** Dilute the detergent with water (10 parts water to 1 part detergent).
    - c.** Rinse and dry thoroughly, then lubricate lightly but evenly with Spinkote to coat all threads.

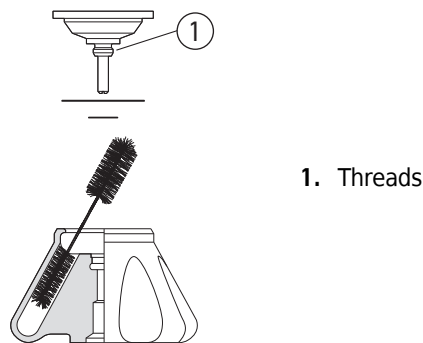

- 
- 7** Periodically remove the O-rings and wipe clean as necessary.
    - a.** Clean the O-ring grooves with a cotton-tipped swab.
    - b.** Reapply a light film of silicone vacuum grease.
-

## Decontamination



If the rotor or other components are contaminated with radioactive, toxic, or pathogenic materials, follow appropriate decontamination procedures as outlined by appropriate laboratory safety guidelines and/or other regulations. Consult *Chemical Resistances* (IN-175) to select an agent that will not damage the rotor

## Sterilization and Disinfection

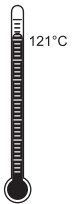

- The rotor and all rotor components can be autoclaved at 121°C for up to one hour. Remove the lid from the rotor and place the rotor, lid, and O-ring in the autoclave upside down.
- Ethanol (70%) or hydrogen peroxide (6%) may be used on all rotor components, including those made of plastic. Bleach (sodium hypochlorite) may be used, but may cause discoloration of anodized surfaces. Use the minimum immersion time for each solution, per laboratory standards.



**Ethanol is a flammability hazard. Do not use it in or near operating ultracentrifuges.**

While Beckman Coulter has tested these methods and found that they do not damage the rotor or components, no guarantee of sterility or disinfection is expressed or implied. When sterilization or disinfection is a concern, consult your laboratory safety officer regarding proper methods to use.

## Storage

When it is not in use, store the rotor in a dry environment (not in the instrument) with the lid removed to allow air circulation so moisture will not collect in the tube cavities.

## Returning a Rotor

---

Before returning a rotor or accessory for any reason, prior permission must be obtained from Beckman Coulter, Inc. The authorization form may be obtained from your local Beckman Coulter sales office. The form, entitled *Returned Material Authorization* (RMA) for United States returns or *Returned Goods Authorization* (RGA) for international returns, should contain the following information:

- rotor type and serial number,
- history of use (approximate frequency of use),
- reason for the return,

- original purchase order number, billing number, and shipping number, if possible,
- name and email address of the person to be notified upon receipt of the rotor or accessory at the factory,
- name and email address of the person to be notified about repair costs, etc.

To protect our personnel, it is the customer's responsibility to ensure that all parts are free from pathogens and/or radioactivity. Sterilization and decontamination must be done before returning the parts. Smaller items (such as tubes, bottles, etc.) should be enclosed in a sealed plastic bag.

*All parts must be accompanied by a note, plainly visible on the outside of the box or bag, stating that they are safe to handle and that they are not contaminated with pathogens or radioactivity. **Failure to attach this notification will result in return or disposal of the items without review of the reported problem.***

Use the address label printed on the form when mailing the rotor and/or accessories.

Customers located outside the United States should contact their local Beckman Coulter office.

## Supply List

---

To order parts and supplies or obtain publications referenced in this manual, call Beckman Coulter Customer Service at 1-800-742-2345 (U.S.A. or Canada) or contact your local Beckman Coulter Representative. Referenced publications may also be available at [www.beckman.com](http://www.beckman.com). See the Beckman Coulter *Ultracentrifuge Rotors, Tubes & Accessories* catalog (BR-8101, available at [www.beckman.com](http://www.beckman.com)) for detailed information on ordering parts and supplies. For your convenience, a partial list is given below.

## Replacement Rotor Parts

| Description              | Part Number |
|--------------------------|-------------|
| TLA-110 rotor assembly   | 366730      |
| Lid assembly             | 366732      |
| Lid O-ring (outer)       | 854519      |
| Lid O-ring (inner)       | 824412      |
| Cap and plunger assembly | 349477      |
| Spring                   | 347903      |
| Rotor vise               | 346133      |

## Other

**NOTE** For MSDS information, go to the Beckman Coulter website at [www.beckman.com](http://www.beckman.com).

| Description  | Part Number                 |
|--|-----------------------------|
| Tubes and accessories  | see <a href="#">Table 1</a> |
| Tube rack  | 355872                      |
| Quick-Seal Cordless Tube Topper kit, 60 Hz                   | 358312                      |
| Quick-Seal Cordless Tube Topper kit, 50 Hz (Europe)          | 358313                      |
| Quick-Seal Cordless Tube Topper kit, 50 Hz (Great Britain)   | 358314                      |
| Quick-Seal Cordless Tube Topper kit, 50 Hz (Australia)       | 358315                      |
| Quick-Seal Cordless Tube Topper kit, 50-Hz (Canada)          | 367803                      |
| Tube Topper rack   | 348122                      |
| OptiSeal tube rack assembly                                  | 361638                      |
| Spacer removal tool (for 3.5-mL and 2.0-mL Quick-Seal tubes) | 338765                      |
| Spacer removal tool (for OptiSeal tubes)                     | 338765                      |
| Tube removal tool  | 361668                      |
| Curved hemostat (6-in.)                                      | 927208                      |
| Fraction Recovery System                                     | 342025                      |
| Fraction Recovery System Adapter Kit for TL-series tubes     | 347828                      |
| Beckman Coulter CentriTube Slicer                            | 347960                      |
| CentriTube Slicer replacement blades (pkg of 10)             | 348299                      |
| CentriTube Slicer adapter (for 13-mm tubes)                  | 354526                      |
| Spinkote lubricant (2 oz)                                    | 306812                      |
| Silicone vacuum grease (1 oz)                                | 335148                      |
| Rotor Cleaning Kit   | 339558                      |
| Rotor Cleaning Brush   | 347404                      |
| Solution 555 (1 qt)  | 339555                      |

# Beckman Coulter, Inc.

## Ultracentrifuge Rotor Warranty

All Beckman Coulter ultracentrifuge Fixed Angle, Vertical Tube, Near Vertical Tube, Swinging Bucket, and Airfuge rotors are warranted against defects in materials or workmanship for the time periods indicated below, subject to the Warranty Conditions stated below.

|   |                        |
|---|------------------------|
| Preparative Ultracentrifuge Rotors      | 5 years — No Proration |
| Analytical Ultracentrifuge Rotors       | 5 years — No Proration |
| ML and TL Series Ultracentrifuge Rotors | 5 years — No Proration |
| Airfuge Ultracentrifuge Rotors          | 1 year — No Proration  |

For Zonal, Continuous Flow, Component Test, and Rock Core Ultracentrifuge Rotors, see separate warranty.

### Warranty Conditions (as applicable)

1. This warranty is valid for the time periods indicated above from the date of shipment to the original Buyer by Beckman Coulter or an authorized Beckman Coulter representative.
2. Maintain one copy of this software for backup purposes (the backup copy shall be supplied by Beckman Coulter);
3. This warranty covers the Beckman Coulter Centrifuge Systems only (including but not limited to the centrifuge, rotor, and accessories) and Beckman Coulter shall not be liable for damage to or loss of the user's sample, non-Beckman Coulter tubes, adapters, or other rotor contents.
4. This warranty is void if the Beckman Coulter Centrifuge System is determined by Beckman Coulter to have been operated or maintained in a manner contrary to the instructions in the operator's manual(s) for the Beckman Coulter Centrifuge System components in use. This includes but is not limited to operator misuse, abuse, or negligence regarding indicated maintenance procedures, centrifuge and rotor classification requirements, proper speed reduction for the high density of certain fluids, tubes, and tube caps, speed reduction for precipitating gradient materials, and speed reduction for high-temperature operation.
5. Rotor bucket sets purchased concurrently with or subsequent to the purchase of a Swinging Bucket Rotor are warranted only for a term co-extensive with that of the rotor for which the bucket sets are purchased.
6. This warranty does not cover the failure of a Beckman Coulter rotor in a centrifuge not of Beckman Coulter manufacture, or if the rotor is used in a Beckman Coulter centrifuge that has been modified without the written permission of Beckman Coulter, or is used with carriers, buckets, belts, or other devices not of Beckman Coulter manufacture.
7. Rotor parts subject to wear, including but not limited to rotor O-rings, VTi, NVT, TLV, MLN, and TLN rotor tube cavity plugs and gaskets, tubing, tools, optical overspeed disks, bearings, seals, and lubrication are excluded from this warranty and should be frequently inspected and replaced if they become worn or damaged.
8. Keeping a rotor log is not mandatory, but may be desirable for maintenance of good laboratory practices.

### Repair and Replacement Policies

1. If a Beckman Coulter rotor is determined by Beckman Coulter to be defective, Beckman Coulter will repair or replace it, subject to the Warranty Conditions. A replacement rotor will be warranted for the time remaining on the original rotor's warranty.

2. If a Beckman Coulter centrifuge is damaged due to a failure of a rotor covered by this warranty, Beckman Coulter will supply free of charge (i) all centrifuge parts required for repair (except the drive unit, which will be replaced at the then current price less a credit determined by the total number of revolutions or years completed, provided that such a unit was manufactured or rebuilt by Beckman Coulter), and (ii) if the centrifuge is currently covered by a Beckman Coulter warranty or Full Service Agreement, all labor necessary for repair of the centrifuge.
3. If a Beckman Coulter rotor covered by this warranty is damaged due to a malfunction of a Beckman Coulter ultracentrifuge covered by an Ultracentrifuge System Service Agreement, Beckman Coulter will repair or replace the rotor free of charge.
4. If a Beckman Coulter rotor covered by this warranty is damaged due to a failure of a Beckman Coulter tube, bottle, tube cap, spacer, or adapter, covered under the Conditions of this Warranty, Beckman Coulter will repair or replace the rotor and repair the instrument as per the conditions in policy point (2) above, and the replacement policy.
5. Damage to a Beckman Coulter rotor or instrument due to the failure or malfunction of a non-Beckman Coulter tube, bottle, tube cap, spacer, or adapter is not covered under this warranty, although Beckman Coulter will assist in seeking compensation under the manufacturer's warranty.

**Beckman Coulter will assist in seeking compensation under the manufacturer's warranty.**

**Disclaimer**

IT IS EXPRESSLY AGREED THAT THE ABOVE WARRANTY SHALL BE IN LIEU OF ALL WARRANTIES OF FITNESS AND OF THE WARRANTY OF MERCHANTABILITY AND BECKMAN COULTER, INC. SHALL HAVE NO LIABILITY FOR SPECIAL OR CONSEQUENTIAL DAMAGES OF ANY KIND WHATSOEVER ARISING OUT OF THE MANUFACTURE, USE, SALE, HANDLING, REPAIR, MAINTENANCE, OR REPLACEMENT OF THE PRODUCT.

**Factory Rotor Inspection Service**

Beckman Coulter, Inc., will provide free mechanical and metallurgical inspection in Indianapolis, Indiana, USA, of any Beckman Coulter rotor at the request of the user. (Shipping charges to Beckman Coulter are the responsibility of the user.) Rotors will be inspected in the user's laboratory if the centrifuge in which they are used is covered by an appropriate Beckman Coulter Service Agreement. Contact your local Beckman Coulter office for details of service coverage or cost.

Before shipping, contact the nearest Beckman Coulter Sales and Service office and request a Returned Goods Authorization (RGA) form and packaging instructions. Please include the complete rotor assembly, with buckets, lid, handle, tube cavity caps, etc. A SIGNED STATEMENT THAT THE ROTOR AND ACCESSORIES ARE NON-RADIOACTIVE, NON-PATHOGENIC, NON-TOXIC, AND OTHERWISE SAFE TO SHIP AND HANDLE IS REQUIRED.

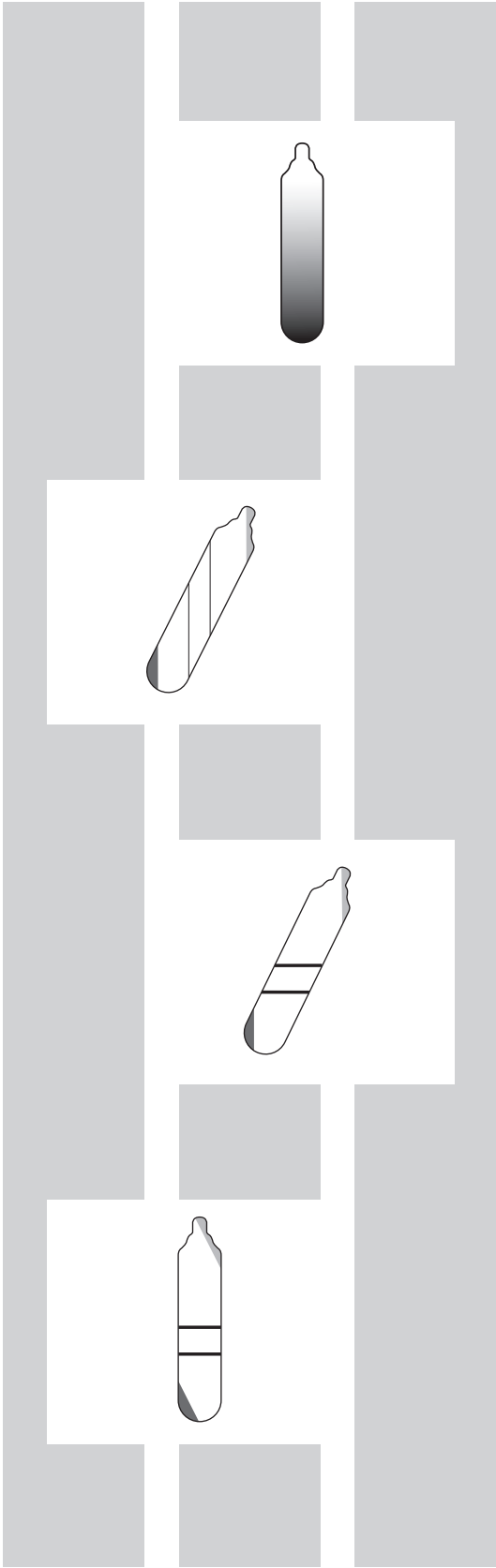

# Related Documents

## **Rotors and Tubes for Beckman Coulter Tabletop Preparative Ultracentrifuges (TLR-IM-9)**

- Rotors
- Tubes and Accessories
- Using Tubes and Accessories
- Using Rotors
- Care and Maintenance
- Chemical Resistances
- The Use of Cesium Chloride Curves
- Gradient Materials
- References

## **Additional References**

- Chemical Resistances for Beckman Coulter Centrifugation Products (IN-175)
- Using OptiSeal Tubes (IN-189)
- Ultracentrifuge Rotors, Tubes, and Accessories catalog (BR-8101)
- *g*-Max System: Short Pathlengths in High Force Fields (DS-709B)

[www.beckman.com](http://www.beckman.com)

